

Translation of the original operating instructions



HLD6000

Leak detector

kinb43en1-03, 1 604

Order no.:
510-025, 510-027,
510-028

Software version:
1.21 or higher (Operating
unit)



No part of this manual may be reprinted, translated or duplicated without the expressed written consent of INFICON GmbH.

Table of Contents

1	About these instructions	7
1.1	Target groups	7
1.2	Other applicable documents	7
1.3	Displaying information	7
1.3.1	Warnings	7
<hr/>		
2	Safety	9
2.1	Intended use	9
2.2	Owner requirements	9
2.3	Operator requirements	10
2.4	Dangers	10
<hr/>		
3	Shipment, Transport, Storage	11
<hr/>		
4	Description	13
4.1	Function	13
4.2	Basic unit	14
4.3	Sniffer line	16
4.4	Technical data	17
<hr/>		
5	Installation	23
5.1	Setup	23
5.2	Sniffer line	23
5.2.1	Connecting the sniffer line	23
5.2.2	Exchanging the sniffer line	23
5.3	Sniffer tip	24
5.3.1	Replacing the sniffer tip	24
5.3.2	Using a water conservation sniffer tip	25
5.3.3	Using flexible sniffer tips	25
5.3.4	Using an extension hose for a sniffer tip	26
5.4	Inserting or replacing a COOL-Check calibration leak	27
5.5	Connecting to the power supply system	27
5.6	Using a USB stick	27
5.7	Connecting a PC	27
<hr/>		
6	Operation	29
6.1	Switching on the device	29
6.2	Operating the device	30
6.2.1	Structure of the touchscreen	30
6.2.2	Measurement view elements	32
6.2.3	Display on the sniffer line	33
6.3	Basic settings	34
6.3.1	Setting the language	34
6.3.2	Setting date and time	34
6.3.3	Adjust volume	34
6.3.4	Setting auto standby	35
6.3.5	Setting the display	35

6.3.6	Set time interval for calibration request	36
6.3.7	Setting the filter change request	36
6.3.8	I/O module	36
6.3.8.1	Create a connection between the device and the I/O module	36
6.3.8.2	Configuring analog outputs	37
6.3.8.3	Setting the upper scale value for 10 V of the analog output	37
6.3.8.4	Setting up the I/O module protocol	37
6.3.8.5	Configuring PLC outputs	37
6.3.8.6	Configuring PLC inputs	38
6.3.8.7	Setting the interface unit	38
6.3.9	Bus module	39
6.3.9.1	Creating a connection between the device and the bus module	39
6.3.9.2	Setting a bus module address	39
6.3.10	Setup scope of error messages	39
6.3.11	Access to the settings	39
6.3.11.1	Protecting settings via PIN assign	40
6.3.11.2	Switching between "supervisor" and "operator" modes	40
6.3.11.3	Changing parameter access controls	40
6.3.12	Save parameters	41
6.3.13	Loading parameters	41
6.3.14	Switching the "Screenshot" function on or off	41
6.4	Settings for the measurements	42
6.4.1	Setting setpoints	42
6.4.2	Setting up the sniffer probe	42
6.4.3	Setting up an alarm profile for setpoints	43
6.4.4	Setting up the gas for the SMART sniffer line	43
6.4.5	Verifying R290 with the sniffer line for R600a/R290	44
6.4.6	Calibration	44
6.4.6.1	Time and type of calibration	44
6.4.6.2	Calibration with an internal COOL-Check	45
6.4.6.3	Calibration with an external calibration leak	46
6.4.6.4	Checking the calibration with an internal COOL-Check	47
6.4.7	Measuring	48
6.4.8	Measured data	49
6.4.8.1	Recording measured data	49
6.4.8.2	Evaluating measured data	50
6.4.8.3	Transferring measured data from the internal memory to a USB stick	50
6.4.8.4	Deleting measurement data	51
6.5	Standby	51
6.6	Diagnosis	51
6.7	Calling up information about the device	51
6.7.1	Parameter list	52
6.8	Updating the software	53
6.8.1	Updating the software of the basic unit	54
6.8.2	Updating the software of the operating unit	54
6.8.3	Updating the software of the sniffer line	55
6.8.4	Updating the software of the I/O module	55
6.9	Switching off the device	55

7	Warning and error messages	57
---	----------------------------------	----

8	Maintenance	63
8.1	Basic unit	63
8.1.1	Replacing the filter plates	63
8.1.2	Cleaning the calibration opening	64
8.1.3	Replacing the fuses	64
8.1.4	Cleaning the device	64
8.2	Sniffer line	65
8.2.1	Replacing the filter holder	65
8.2.2	Changing the filter block	66
8.3	Sending for repair or maintenance	66

9	Decommissioning the device	67
9.1	Disposing of the device	67
9.2	Sending in the device	67

10	Appendix	69
10.1	Accessories and spare parts	69
10.2	Menu trees	70
10.3	CE Declaration of Conformity	72

	Index	73
--	-------------	----

1 *About these instructions*

This document applies to the software version stated on the title page.

1.1 *Target groups*

These operating instructions are intended for the operator of the HLD6000 leak detector and for technically qualified personnel with experience in leak detection technology.

1.2 *Other applicable documents*

Interface Protocols, document no. kirb43e1

1.3 *Displaying information*

1.3.1 *Warnings*

 DANGER
Imminent threat resulting in death or serious injuries

 WARNING
Hazardous situation resulting in potential death or serious injuries

 CAUTION
Hazardous situation resulting in minor injuries

NOTICE
Hazardous situation resulting in damage to property or the environment

2 Safety

2.1 Intended use

The device is a leak detector for sniffer leak detection. With the device you locate and quantify leaks on test objects. The HLD6000 sniffs for different gases depending on which sniffer line is connected. The following sniffer lines are available:

- SMART sniffer line for R22, R32, R134a, R404A, R407C, R410A, R1234yf, R1234ze and 3 additional gases from the selectable gases that are verifiable by the device,
- Sniffer line for R744 (CO₂),
- Sniffer line for R600a and R290.

A test object always contains gas under overpressure. Check the exterior of the test objects for escaping gas using a sniffer line (sniffing method).

- ▶ You must install, operate and service the device only in compliance with these operating instructions.
- ▶ Adhere to the restrictions of use (see "4.4 Technical data", page 17).

Unauthorized use

- ▶ Do not suck up liquids with the device.
- ▶ Never hold the sniffer probe into liquids but sniff only for gases.

2.2 Owner requirements

The following notes are for companies or any person who is responsible for the safety and effective use of the product by the user, employee or third party.

Safety conscious operation

- ▶ Only use the device when it is technically in good order and condition.
- ▶ Only operate the device in accordance with this instruction manual, in a safety and risk conscious manner.
- ▶ Adhere to the following regulations and observe their compliance:
 - Intended use
 - Generally applicable safety and accident prevention regulations
 - International, national and local standards and guidelines
 - Additional device-related provisions and regulations
- ▶ Only use original parts or parts approved by the manufacturer.
- ▶ Keep this instruction manual available on site.

Personnel qualifications

- ▶ Only instructed personnel should be permitted to work with and on the device. The instructed personnel must have received training on the device.
- ▶ Personnel in training should only be allowed to work with and on the device under the supervision of trained qualified service technicians.
- ▶ Make sure that the authorized personnel have read and understood the operating instructions and all other applicable documents, especially the information on safety, maintenance and repairs, before starting work (see "1.2 Other applicable documents", page 7).
- ▶ Regulate the responsibilities, authorizations and supervision of personnel.

2.3 Operator requirements

- ▶ Read, observe and follow the information in these operating instructions and the working instructions created by the owner, especially the safety instructions and warnings.
- ▶ Carry out any work only based on the complete operating instructions.
- ▶ If you have any questions regarding operation or maintenance that you cannot find answers to in these instructions, please contact INFICON customer service.

2.4 Dangers

The device was built according to the state of the art and the recognized safety regulations. Nevertheless, improper use may result in risk to life and limb on the part of the user or third parties, or damage to the device or other property may occur.

Hazards due to liquids and chemicals

Liquids and chemical substances can damage the device.

- ▶ Adhere to the restrictions of use (see "4.4 Technical data", page 17).
- ▶ Do not suck up liquids with the device.
- ▶ Never try to find toxic, caustic, microbiological, explosive, radioactive or other harmful substances with the device.
- ▶ Only use the device away from areas with a risk of explosions.
- ▶ Do not expose the device to a naked flame and avoid spark formation, for example, by smoking.

Dangers from electric power

There is a danger to life from the contact of conductive parts inside the device.

- ▶ Disconnect the device from the power supply prior to any installation and maintenance work. Ensure that the electricity supply cannot be switched back on unintentionally.

Contact of the sniffer tip with live parts may result in danger to life.

- ▶ Before starting the leak test, disconnect electrically operated test objects from the power supply. Ensure that the electricity supply cannot be switched back on unintentionally.

The device contains electric components that can be damaged from high electric voltage.

- ▶ Before connecting the device to the power supply, make sure that the supply voltage specified on the device is the same as the local power supply.

Dangers from strong exposure to light

Eye exposure to LED light can lead to permanent eye damage.

- ▶ Do not look into the LEDs of the sniffer probe from a short distance or for longer periods of time.

3 Shipment, Transport, Storage

Shipment

Table 1: Shipment

Item	Quantity
HLD6000 (Basic unit)	1
Sniffer line with sniffer tip (100 mm)	1
Mains cable, country-specific	1 or 2
Fuses	4
Filter holder for sniffer tip	5
Filter blocks for sniffer tip	4
Operating instructions	1
Interface description	1
USB stick with instructions, software	1

► Check the scope of delivery of the product for completeness after receipt.

You can also order separately:

- The COOL-Check calibration leak.

Accessory list: see "10.1 Accessories and spare parts", page 69

Transport

NOTICE

Damage caused by transport

Transport in unsuitable packaging material can damage the device.

- Retain the original packaging.
- Only transport the device in its original packaging.

Storage

Always store the device in compliance with the technical data, see "4.4 Technical data", page 17.

NOTICE

Losses due to overly prolonged storage

The service life of a COOL-Check is limited.

- Do not create inventories.
- Store the COOL-Check in a cool, dry place.

4 Description

4.1 Function

The HLD6000 is made up of a basic unit and a line with handle. This line is referred to as the sniffer line.

To locate leaks, move the tip of the sniffer line over places from which gas may be escaping. Depending on the design of the sniffer line, you can detect different gases.

In the handle the sniffer line emits a source infrared light, which hits an infrared sensor. If a traceable gas enters the sniffer line with the suctioned air, the light intensity reduces.

Based on the change in light intensity, the HLD6000 measures gases and shows the result optically and acoustically. Measured values are represented on the touchscreen of the basic unit.

Traces of the measured gases are frequently found in the atmosphere. The HLD6000 measures the air in the atmosphere and takes the background concentration of the measured gas and other unwanted gases into account when calculating the measured value.

To be able to find leaks that exceeds a specific gas concentration, set one or two setpoints on the basic unit. If you work with two setpoints, you can toggle between both values whilst measuring by pressing a button.

4.2 Basic unit

The basic unit is only called a “device” in the following as long as the meaning remains clear.

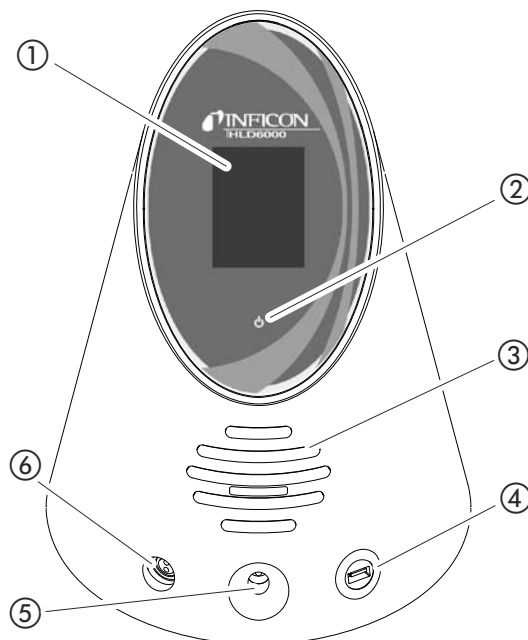

Fig. 1: Frontal view

- | | |
|-------------------------|--|
| ① Touchscreen | ④ USB connection |
| ② LED operating display | ⑤ Calibration opening for internal calibration |
| ③ Speaker | ⑥ Sniffer line connection port |

② LED operating display

Operating display with 3 statuses:

- green = in operation
- flashing green = unit in operation, touchscreen switched off
- red = malfunction

④ USB connection

For use of a USB stick see "5.6 Using a USB stick", page 27.

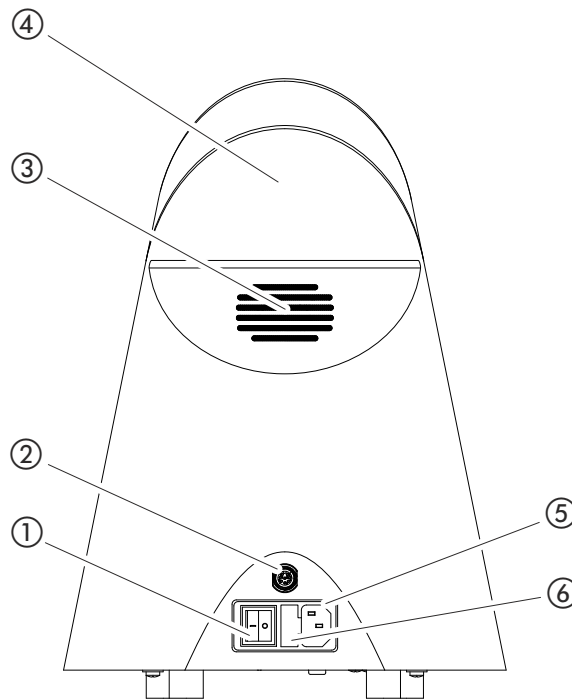

Fig. 2: Rear view

- | | |
|---------------------|--------------------------|
| ① Mains plug | ④ Carry handle |
| ② M12 socket | ⑤ Power cable connection |
| ③ Ventilation slots | ⑥ Cover for fuse holder |

① Mains plug

The mains plug is used to switch the device on and off.

② M12 socket, 8-pin

– For connection of the INFICON I/O module, available as an accessory see "[6.3.8 I/O module](#)", page 36.

– Length of the data cable: Max. 30 m

⑥ Cover for fuse holder

For exchanging fuses see "[8.1.3 Replacing the fuses](#)", page 64.

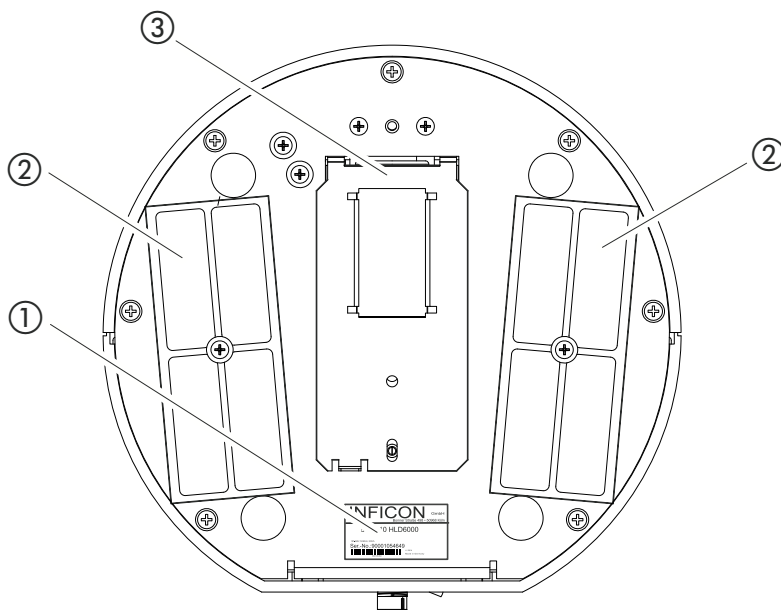

Fig. 3: View from below

- ① Rating plate with information regarding supply voltage, serial number and production date.
- ② Filter plates
- ③ COOL-Check calibration leak behind the cover

4.3 Sniffer line

You need a sniffer line to operate the device. There are sniffer lines for verification of a single gas or sniffer lines for the verification of several gases [see "2.1 Intended use", page 9](#) and [see "10.1 Accessories and spare parts", page 69](#). The sniffer line which is delivered as standard is 4.8 m long.

The sniffer line is made of a line, a sniffer probe, and a sniffer tip. The filter holder at the end of the sniffer tip is made of plastic. This reduces the risk of scratching the surfaces to be sniffed.

Sniffer tip

There are rigid and flexible sniffer tips of different lengths, [see "10.1 Accessories and spare parts", page 69](#).

Sniffer probe

During measurement it is possible to switch the setpoint using the button on the sniffer probe, provided that this function is activated, [see "6.4.2 Setting up the sniffer probe", page 42](#).

The button on the sniffer probe is also used during calibration, [see "6.4.6.2 Calibration with an internal COOL-Check", page 45](#).

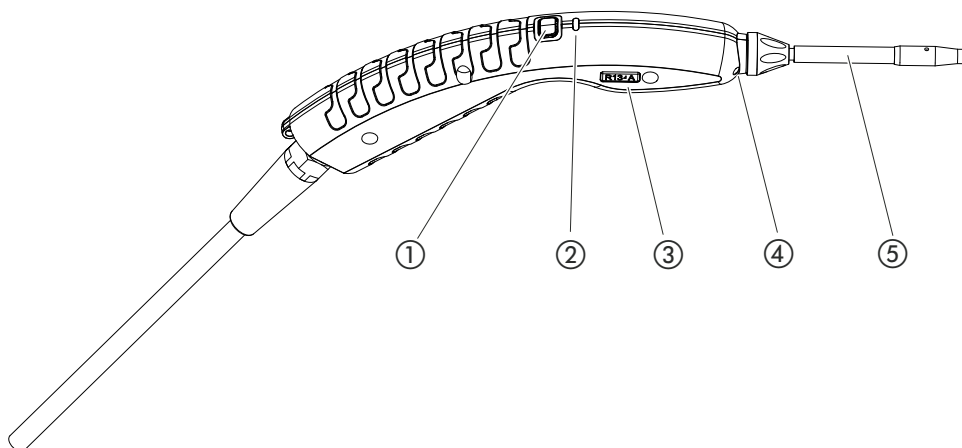

Fig. 4: Handle: Display and functions

- ① Key
- ② Status LED
- ③ Name of gas or sniffer line
- ④ Illumination LED
- ⑤ Sniffer tip

If the setpoint is exceeded, the display switches from green to yellow, see "Table 7: Signals of the LED on the handle grip", page 33.

You can also set the illumination LEDs to flash at the lower end of the sniffer probe, see "6.4.2 Setting up the sniffer probe", page 42.

4.4 Technical data

Table 2: Technical data

Mechanical data	
Basic unit	
Dimensions (height; diameter)	365 mm; 260 mm (14.4 in.; 10.25 in.)
Weight	4.1 kg (9 lb.)
Length of sniffer line	4.8 m (15.5 ft.)
Weight of sniffer probe	280 g (0.6 lb.)
Environmental conditions	
Permissible ambient temperature (during operation)	5 °C to 50 °C (40-122 °F)
Permissible storage temperature	0 °C to 50 °C (32-122 °F)
Max. relative humidity up to 31 °C (87.8 °F)	80 %
Max. relative humidity from 31 °C to 40 °C (87.8 °F-104 °F)	linearly decreasing from 80% to 50%
Max. relative humidity above 40 °C (104 °F)	50 %
Pollution degree	II (According to IEC 61010/ Part 1: "Usually, only non-conducting contamination may occur. However, temporary conductivity caused by condensation is permissible at times.")
Max. altitude above sea level	2000 m

Table 2: Technical data (Contin.)

Electrical data	
Power supply and frequencies	100 ... 240V 50/60 Hz
Power consumption	55 VA
Protection class	IP 30
Excess voltage category	II
Mains fuse	2 x 1 A slow-blowing (Ø 5 × 20 mm)
Power supply cable	2.5 m (8.2 ft.)
Length of the data cable on the M12 plug	Max. 30 m (98.4 ft.)
Noise level without signal tones	< 54 dBA
Physical Data	
Minimum detectable leak rate	
R744 (CO ₂)	1.0 g/a (0.04 oz/yr)
R600a/R290	1.0 g/a (0.04 oz/yr); for R600a/R290 see "6.4.5 Verifying R290 with the sniffer line for R600a/R290", page 44
SMART	0.5 g/a (0.02 oz/yr); see "6.4.4 Setting up the gas for the SMART sniffer line", page 43
Measurement range of sniffer probes	
Individual gases	0 - 100 g/a (3.57 oz/yr)
SMART	0 - 300 g/a (10.7 oz/yr)
Time constant of the signal from the leakage rates	< 1 s
Gas flow Measured at 1 atm (1013 mbar) at sea level. The flow rate changes with the geographical height and barometric pressure.	320 sccm
Time until ready for operation	< 30 s
Response time	< 1 s

Table 3: General factory settings

(For current device settings see "6.7.1 Parameter list", page 52)

Analog output upper limit	100 g/a
Display off after	1 h
Display brightness	100 %
Diagram maximum value (log.)	+3
Diagram maximum value (lin.)	20.0 g/a
Display upper limit (lin.)	300.0 g/a
Display upper limit (log.)	+3
Display unit leakage rate	g/a
Auto scale	on
Screen tap sound	Soft
Bus module address	126
Data record	Off
Diagram of the leakage rate	Line graph
Factor user gas 1	0.0
Factor user gas 2	0.0
Factor user gas 3	0.0

Table 3: General factory settings (Contin.)

Error information operator	No. and text
Error information supervisor	No., text and info
Filter change request	On
Filter change interval	40 hours
Gas of R600a sniffer line	R600a
Gas of SMART sniffer line	R134a
Gas of R600a sniffer line	R600a
I/O module protocol	ASCII
Auto standby interval	2 min.
Interval for calibration request	60 min.
Calibration factor	15.0 (Calibration factor during initial setup. The calibration factor cannot be reset to factory settings. It can be changed by the service team.)
Config. Analog output 1	Leakage rate linear
Config. Analog output 2	Leakage rate linear
Configuration PLC Output 1	Setpoint 1 (inverse)
Configuration PLC Output 2	Setpoint 2 (inverse)
Configuration PLC Output 3	Open
Configuration PLC Output 4	Open
Configuration PLC Output 5	Measuring
Configuration PLC Output 6	Error (inverse)
Configuration PLC Output 7	CAL request (inverse)
Configuration PLC Output 8	Open (inverse)
Configuration PLC Input 1	No function
Configuration PLC Input 2	No function
Configuration PLC Input 3	Start/Stop (inverse)
Configuration PLC Input 4	No function
Configuration PLC Input 5	CAL extern
Configuration PLC Input 6	No function
Configuration PLC Input 7	Delete
Configuration PLC Input 8	No function
Configuration PLC Input 9	No function
Configuration PLC Input 10	No function
Volume	5
Leakage rate setpoint 1	5.0 g/a
Leakage rate setpoint 2	10.0 g/a
Show measured value	On
Module at M12 connector	I/O
Name user gas 1	User 1
Name user gas 2	User 2
Name user gas 3	User 3
Phase	20 (Phase during initial setup. The phase cannot be reset to factory settings. It can be changed by the service team.)
Calibration leak external	10 g/a
Interface unit leakage rate	g/a

Table 3: General factory settings (Contin.)

Sniffer light alarm configuration	Flashing
Sniffer light brightness	4
Probe key configuration	Setpoint
Setpoint audio alarm	Setpoint
Screenshot with probe key	Off
Record interval	500 ms
Memory location	USB
Language	English
Show warnings	On
Value axis decades	3
Value axis grid	Linear
Time axis scale	30 s

Table 4: Factory settings for access authorization

Parameter access control	
Analog output upper limit	Supervisor
Display off after	Operator
Display brightness	Operator
Diagram maximum value (log.)	Operator
Diagram maximum value (lin.)	Operator
Display upper limit (lin.)	Operator
Display upper limit (log.)	Operator
Display unit leakage rate	Operator
Auto scale	Operator
Screen tap sound	Operator
Bus module address	Supervisor
Data record	Operator
Date and time	Supervisor
Diagram of the leakage rate	Operator
Factor user gas	Supervisor
Error information operator	Supervisor
Error information supervisor	Supervisor
Filter change request	Supervisor
Filter change interval	Supervisor
Gas of R600a sniffer line	Supervisor
Gas of SMART sniffer line	Operator
I/O module protocol	Supervisor
Auto standby interval	Supervisor
Calibration request interval	Supervisor
Calibration factor	Service
Config. Analog output	Supervisor
Configuration PLC Output	Supervisor
Configuration PLC Input	Supervisor
Volume	Operator
Leakage rate setpoint	Supervisor

Table 4: Factory settings for access authorization (Contin.)

Show measured value	Operator
Module at M12 connector	Supervisor
Name user gas	Supervisor
Phase	Service
Calibration leak external	Supervisor
Interface unit leakage rate	Supervisor
Sniffer light alarm configuration	Supervisor
Sniffer light brightness	Supervisor
Probe key configuration	Supervisor
Setpoint audio alarm	Supervisor
Screenshot with probe key	Supervisor
Record interval	Operator
Memory location	Operator
Language	Operator
Show warnings	Service
Value axis decades	Operator
Value axis grid	Operator
Time axis scale	Operator

5 Installation

5.1 Setup



WARNING

Danger from moisture and electricity

Moisture entering the device can lead to personal injury due to electric shocks as well as to property damage due to short circuiting.

- ▶ Only operate the device in a dry environment.
- ▶ Operate the device away from sources of liquid and moisture.

NOTICE

Material damage from overheated device

The device heats up during operation and can overheat without sufficient ventilation.

- ▶ Please note the technical data, [see page 17](#).
- ▶ Ensure sufficient ventilation, especially on the ventilation slots on the left and right of the device: at least 20 cm of free space on the sides, at least 10 cm in the front and rear.
- ▶ Keep heat sources away from the device.
- ▶ Do not expose the device to direct sunlight.

5.2 Sniffer line

5.2.1 Connecting the sniffer line

Connect the sniffer line before you start up the device.

If the sniffer line is not connected then the device reports an error.

If you remove the sniffer line during operation, the device also reports an error.

- 1 Align the red marking on the sniffer line plug with the red marking on the socket of the device ([see Fig. 1 on Page 14](#)).
- 2 Push the sniffer line plug into the socket on the device until it locks into place. The plug may no longer be easy to move.

5.2.2 Exchanging the sniffer line

- 1 Select the sniffer line of the gas you wish to detect.
- 2 Switch the device off.
- 3 To release the plug on the sniffer line from the socket of the device, pull the grooved ring on the plug until the lock is opened.
- 4 Pull off the sniffer line.

5 Attach the new sniffer line.

You can switch the device back on again.

5.3 Sniffer tip

5.3.1 Replacing the sniffer tip

NOTICE

Material damage from pollution

Particles in the air intake can destroy the sniffer line.

- ▶ Always switch off the device before every installation!
- ▶ Make sure that no particles enter into the air intake when replacing sniffer probe parts.

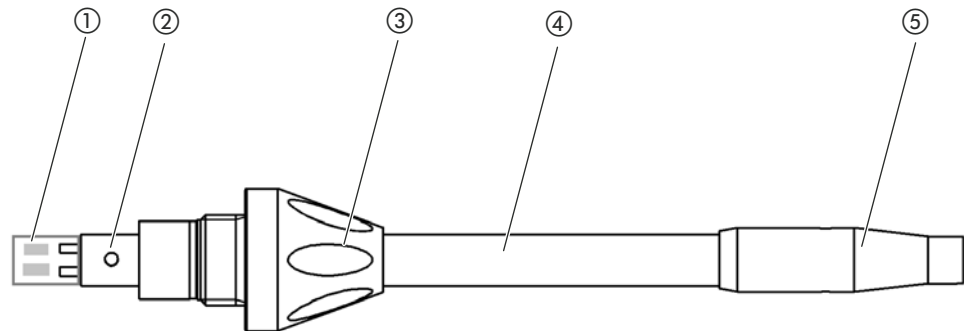

Fig. 5: Sniffer tip

- | | |
|----------------|-----------------|
| ① Filter block | ④ Sniffer tip |
| ② Guide pin | ⑤ Filter holder |
| ③ Cap nut | |

1 Switch the device off.

2 Loosen the cap nut until the sniffer tip can be pulled out.

3 Insert the new sniffer tip into the sniffer probe in such a way that the guide pin runs into the groove of the sniffer probe opening.

4 Tighten the cap nut.

5 Calibrate the device, see "6.4.6.1 Time and type of calibration", page 44.

Further sniffer tips see "10.1 Accessories and spare parts", page 69.

To replace the filter see "8.2 Sniffer line", page 65.

5.3.2 Using a water conservation sniffer tip

If there is a risk of sucking in liquids then a water conservation tip should be used, see "10.1 Accessories and spare parts", page 69.

You can use the water conservation sniffer tip to check test objects with low surface moisture, e.g. condensation moisture, for leaks.

- ▶ Screw the water conservation sniffer tip to the end of the filter holder.

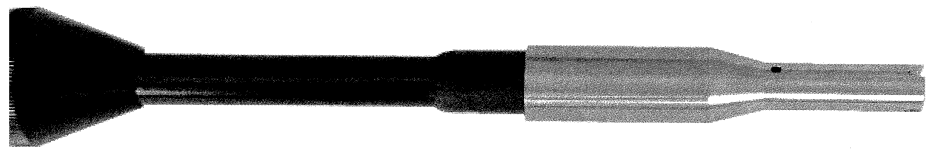

Fig. 6: Water protection sniffer tip installed

NOTICE

Risk of short circuit

Sucked in liquid can destroy the device.

- ▶ Do not suck up liquids with the device.

Do not hold the sniffer line with the sensor pointing up since moisture will flow into the sensor as a result. If liquid has been spilled in the direction of the sensor, hold the sniffer line with the tip pointing down and run the device for about 10 minutes.



With the water conservation sniffer tip installed, you cannot calibrate with the internal COOL-Check.

5.3.3 Using flexible sniffer tips

If you are examining test objects which have already been packed or test objects with areas that are difficult to access then an extended sniffer tip can be used, see "10.1 Accessories and spare parts", page 69.

In addition to the rigid sniffer tip what comes delivered with the HLD6000 you can also use a 400 mm long flexible tip. By bending the flexible tip accordingly, hard-to-reach areas can also be accessed.

5.3.4 Using an extension hose for a sniffer tip

To get into hard-to-reach areas, attach an extension hose to the sniffer tip, see "10.1 Accessories and spare parts", page 69.

Note that you cannot trace CO₂ with an extension hose!

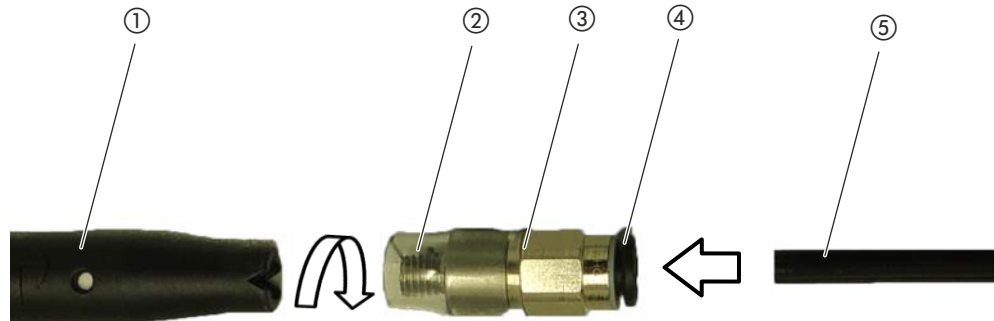

Fig. 7: Attach the extension hose

- ① Filter holder on the sniffer tip
- ② Short extension hose
- ③ Adapter
- ④ Release ring
- ⑤ Extension hose

If it is necessary to shorten the extension hose, cut off the end of the extension hose that you use to sniff the test object at an angle of about 45°.

- 1 To attach the extension hose to the sniffer tip, screw the adapter from the set with the extension hose to the filter holder at the end of the sniffer tip. Make sure that the short extension hose at the end of the adapter encloses the filter holder.
- 2 Insert the extension hose into the rear opening of the adapter. The extension hose is automatically locked into position.
- 3 To connect the extension hose to the calibration opening for internal calibration for the COOL-Check, insert the centering ring into the calibration opening on the device to make the COOL-Check opening smaller.



Fig. 8: Insert centering ring

Disassembly

- ▶ To remove the extension hose press the release ring in the direction of the adapter so that the locking device releases and thus enables the extension hose to be removed.

i With the extension hose installed, you cannot calibrate with an external CO₂ calibration leak.

5.4 Inserting or replacing a COOL-Check calibration leak

A built-in calibration leak (COOL-Check) and various external calibration leak devices are available as accessories for the device, see "10.1 Accessories and spare parts", page 69.

No COOL-Check is available for the R744 (CO₂) and R600a/R290 gases. Solely calibrate the sniffer line for the R744 and R600a/R290 gas using external calibration leaks.

Please refer to the COOL-Check installation instructions on how to connect or change the COOL-Check.

5.5 Connecting to the power supply system

WARNING

Danger from electric shock

Improperly earthed or protected products may be dangerous to life in case of a fault. The use of the device is not permitted without a connected protective conductor.

- ▶ Only use the included 3-wire power cable.

CAUTION

Danger due to incorrect supply voltage

Incorrect supply voltage can destroy the device and injure persons.

- ▶ Check whether the supply voltage specified on the rating plate of the device matches the supply voltage available on site.

The device cannot be switched over for other supply voltages.

5.6 Using a USB stick

With a USB stick, you can

- Record measured data, see "6.4.8.1 Recording measured data", page 49
- Save settings, see "6.3.12 Save parameters", page 41,
- Save histories,
- Store measured data, see "6.4.8.3 Transferring measured data from the internal memory to a USB stick", page 50.

The USB stick must be formatted in the FAT file system.

5.7 Connecting a PC

Connection is done using the I/O module, see "10.1 Accessories and spare parts", page 69.

Please refer to the "Interface Protocols" (doc. no. kirb43e1) for further information on data exchange.

6 Operation

6.1 Switching on the device

Connect a sniffer line and switch on the device.

The device will start up and, after a short time, display "Reading data".



Fig. 9: The device starts up

In order to switch to English from another language, press "EN" on the depicted window.

After the run-up, the device will measure the leakage rate on the sniffer line. There is no separate Start function.

- ▶ Change the basic settings [see "6.3 Basic settings", page 34](#).
- ▶ Make adjustments to settings for the measuring process and calibrate the device [see "6.4 Settings for the measurements", page 42](#).





If the COOL-Check calibrated leak is not located in the device, an acoustic warning signal sounds and the 163 warning message is issued during the initial start-up.

If calibration is required, the warning 630 "Calibration request" is issued, [see "6.2.2 Measurement view elements", page 32](#).

- ▶ To close this warning message, press the  button.

6.2 Operating the device

6.2.1 Structure of the touchscreen

The display primarily works with symbols. Four symbols are always shown on the display: the navigation buttons    . You also see other symbols and elements depending on the context, see "Table 6: Function buttons", page 31.

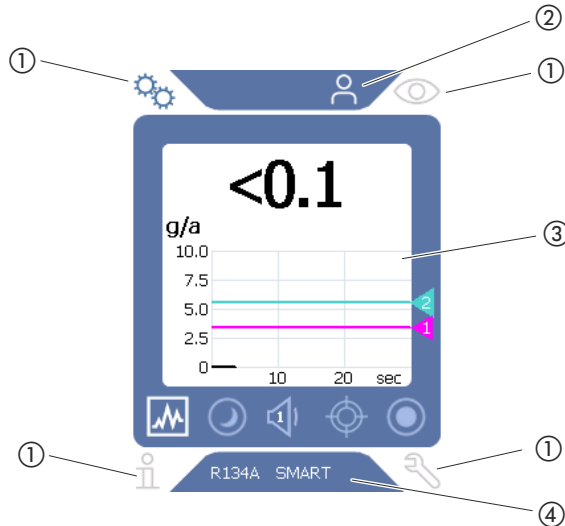

Fig. 10: Start screen after starting up

- ① Navigation buttons
- ② Menu bar (in this case, enabled for operators)
- ③ Main display area
- ④ Status bar (in this case, gas and connected handle)

① Navigation buttons

Four navigation buttons are located in the four corners of the display. Use the navigation buttons to control the various areas and functions of the device.

To get an overview of the available options, look at the illustration of the menu trees see "10.2 Menu trees", page 70.

The navigation buttons use different colors to show their status:

Table 5: Navigation buttons

The buttons can appear in five different colors:	
	– Gray: Function locked
	– Dark blue: Function can be activated
	– Light blue: Function active
	– Red: Error message displayed
	– Orange: Warning displayed
	– Settings symbol
	– Change settings on the device
	– Back one settings level

Table 5: Navigation buttons (Contin.)

	<ul style="list-style-type: none"> – Symbol for operation – Call up measurement display – Display active error or warning message
	<ul style="list-style-type: none"> – Information symbol – Display information regarding the device such as the software version, operating hours, serial number, date and time – Navigate back to the previous information layer
	<ul style="list-style-type: none"> – Diagnostics symbol – Call up diagnostic functions: Service settings, history lists, software update – Navigate back to the previous diagnosis layer – Show active, confirmed warning

② Menu bar

The blue menu bar shows you whether you are logged in as a supervisor or as an operator , see "6.3.11 Access to the settings", page 39.

③ Main display area

The function buttons are located in the blue margin of the main display area. The navigation buttons use different colors to show their status.

Table 6: Function buttons

The buttons can be displayed in three different colors: gray, light blue, white.	
<ul style="list-style-type: none"> – Gray: Function is disabled, – Light blue: Function can be activated, – White: Function is active. 	
Symbol buttons for measuring and for standby	
	Use this button to change the display from a bar graph to a line graph.
	Use this button to change the display from a line graph to a bar graph.
	Change between being in standby or out of standby
	Set the volume for speakers The set volume is displayed on the bottom edge of the display. Value range: 0 (off) to 15 (max.)
	Call up external calibration see "6.4.6.3 Calibration with an external calibration leak", page 46.
	Starting or stopping the data record see "6.4.8 Measured data", page 49
Function symbols during calibration	
	Cancel calibration
	Calling up help for calibration
General function symbols	
	Cancel ongoing function
	Call up help for the current function
	Confirm entry or selection

The measurement display is also located within the range. For more information, see "6.2.2 Measurement view elements", page 32.

④ *Status bar*

A text appears in the blue status bar with information about the main display area.

Recalibrating the touchscreen

The HLD6000 is delivered with a calibrated touchscreen. If required, you can recalibrate the touchscreen.

- 1 Switch the device off.
- 2 Remove the sniffer line.
- 3 Switch on the device without connected sniffer line.
- 4 If error message 130 is displayed, lead the sniffer tip into the calibration opening at the front of the basic unit within 30 seconds.
Touch calibration is started.
- 5 Follow the instructions on the touchscreen.
- 6 Switch the device off and reconnect the sniffer line.

6.2.2 Measurement view elements

The measured leakage rates are displayed numerically and with a linearly subdivided graph. Exceeding the setpoint which is set up is illustrated in color, see "6.4.1 Setting set-points", page 42.

The following diagram shows additional elements relating to the measurement display:

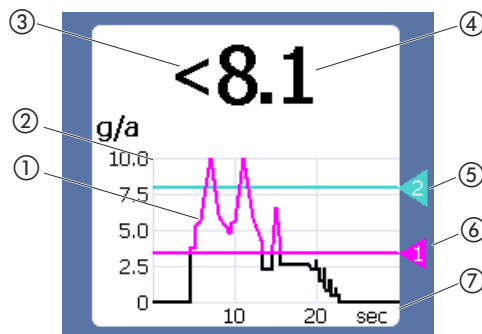

Fig. 11: Measurement display elements

- | | |
|--|---------------------------------------|
| ① Measurement history (bar or line graph) | ④ Numeric display of the leakage rate |
| ② Value axis | ⑤ Setpoint 2 |
| ③ If the measured value is lower than that of the lower display limit, the "<" sign is used. | ⑥ Setpoint 1 |
| | ⑦ Time axis |

i After switching off warning 630 "Calibration request", the message "Calibration required!" is displayed flashing above the measurement display diagram. This message disappears after recalibration, see "6.4.6 Calibration", page 44.

6.2.3 Display on the sniffer line

A status LED is mounted on the sniffer line probe where you can read the different operating modes, see "Table 7: Signals of the LED on the handle grip", page 33.

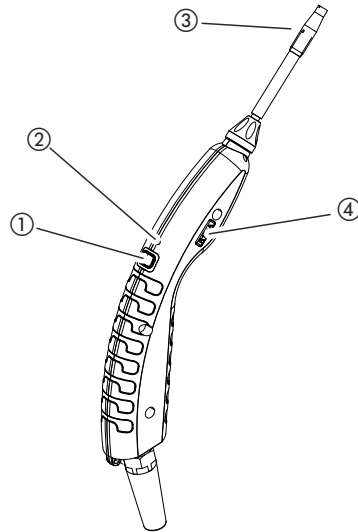

Fig. 12: Sniffer line display

- ① Calibration button, see "6.4.6.1 Time and type of calibration", page 44
- ② Status LED
- ③ Filter holder on the sniffer tip
- ④ Designation of the gas that the sniffer line sniffs.

Table 7: Signals of the LED on the handle grip

Operating status	LED
Not connected	Off
No communication	Blue, flashing
Run up	Blue
Standby	Blue, flashing
Measuring mode	Green
Leakage rate >40 % of the setpoint	Yellow
Leakage rate >100 % of the setpoint	Yellow, flashing
Calibration	Blue, flashing
Error/Warning	Red, flashing
Error/Warning and leakage rate > 40 % of the setpoint	Red/green, flashing
Error/Warning and leakage rate > 100 % of the setpoint	Red/yellow, flashing

6.3 Basic settings

Overview

- To get an overview of the available options, look at the illustration of the menu trees see "10.2 Menu trees", page 70.
- You can either carry out your own changes or keep the factory settings, see "Table 3: General factory settings", page 18 or see "Table 4: Factory settings for access authorization", page 20.
- Your settings can be saved at any time to restore to an earlier state if required, see "6.3.12 Save parameters", page 41.

6.3.1 Setting the language

You can choose from the following languages for the touchscreen display:

- English (factory setting)
 - German
 - French
 - Italian
 - Spanish
 - Portuguese
 - Chinese
 - Japanese
- ▶ Select "⚙️ > Setup > Language".

In order to switch to English from another language directly after switching on the device, press "EN" on the device's touchscreen during run-up.

6.3.2 Setting date and time

Date and time are stored in the following formats:

- Date in the DD.MM.YY format
 - Time in the HH:MM format
- ▶ Select "⚙️ > Setup > Date and Time".

6.3.3 Adjust volume



WARNING

Hearing damage from excessively loud signal tones

The volume of the signal tones can exceed 85 dB(A).

- ▶ Keep away from the device when setting high volumes.
- ▶ Wear ear protection when necessary.

Volume

You can adjust a volume. The setting applies to the speaker in the basic unit. Setting range: 0 to 15

Test

A tone at the set volume is issued.

Screen tap sound

Three possible settings: Off, Soft, Loud.

- ▶ To adjust the volume, select "⚙️ > Volume".
Alternatively, when on the touchscreen select the button ◀.

6.3.4 Setting auto standby

As well as having the option to manually switch over into standby mode (see "6.5 Standby", page 51), it is also possible to set up an auto standby function. This setting defines the period of time after that the device automatically enters standby mode when not in use. The following settings are available:

- Standby off
- Set the time between one and 15 minutes.
- ▶ To set up the automatic standby mode, select "⚙️ > Setup > Auto Standby".

6.3.5 Setting the display

You can modify the type of display in the "Display Settings" menu by selecting the following buttons:

- "Value display"
 - For displaying the measurements as a bar or line graph
 - For switching the measurement display on or off
- "Value axis"
 - "Value axis grid": For switching between a linear and logarithmic view
 - "Value axis decades": If the logarithmic view is selected for "value axis grid" then you can choose whether 1, 2, 3, or 4 decades are displayed.
- "Scaling value axis"
 - "Auto scale": For switching auto scale on or off
 - "Display maximum value (log.) exponent": If the auto scale is switched off and the logarithmic view is selected then you can set the exponent of the upper display value.
 - "Display maximum value (lin.)": If the auto scale is switched off and the linear view is selected then you can set the upper display value.
- "Time axis"
 - For changing the time axis between 15 s, 30 s, 60 s, 120 s, 240 s, 480 s, 960 s
- "Units"

For displaying the leakage rate

 - g/a (factory setting)
 - lb/yr
 - mbar l/s
 - oz/yr
 - Pa m³/s

- "Brightness"
 - "Display brightness": For selecting brightness, choose between 20, 30, 40, 50, 60, 70, 80, 90, or 100 %
 - "Display off after": Choosing whether the display is switched off after 30 s, 1 min., 2 min., 5 min., 10 min., 30 min., or 1 h.
The time runs after a key on the touchscreen has been pressed for the last time or a status change has taken place (exceeding the setpoint, appearance of a warning, etc.).
 - "Display limits"
 - "Display upper limit (log.) exponent": The displayed value is limited to this value. The values 0, 1, 2 or 3 are possible.
 - "Display upper limit (lin.)": This is for establishing an upper limit (lin.), for example between 5, 10, 20, 50, 100, 200 or 300 g/a.
- ▶ To adjust the display details of the display, select "⚙️ > Display Settings" and the desired button.

6.3.6 Set time interval for calibration request

You can switch off the time-controlled calibration request or set intervals between 30 minutes and 24 hours, after which a calibration request is displayed.

- 1 Select "⚙️ > Setup > Request".
- 2 Select "off" or input a time interval.
- 3 Confirm your selection using the button ⏴.

6.3.7 Setting the filter change request

You can set whether a request for replacing the filter holder should appear automatically after a certain time, see "8.2.1 Replacing the filter holder", page 65.

- 1 Select "⚙️ > Setup > Request".
- 2 Choose "on" or "off".
- 3 If you have chosen the setting "On", you can set the timespan between two requests.
- 4 Confirm your selection using ⏴.

6.3.8 I/O module

Introduction information: Instruction manual IO1000 I/O module, document no. jiqc10

6.3.8.1 Create a connection between the device and the I/O module



To create the connection between the I/O module and the device, do the following:

- 1 Switch the device off.
- 2 Connect the INFICON I/O module with a data cable to the M12 socket on the rear of the device, see Fig. 2 on Page 15.
- 3 Switch on the HLD6000.
- 4 Select "⚙️ > Setup > Interfaces > Device Selection".
- 5 Select "I/O".

- 6 Confirm your settings using .



6.3.8.2 **Configuring analog outputs**

You can determine how the voltage of the analog outputs is set.

- 1 Select " > Setup > Interfaces > I/O Module > Analog Outputs".
- 2 For "Config. Analog Output 1" or "Config. Analog Output 2" choose between:
 - Set by interface
 - Leakage rate linear
 - Off
- 3 Confirm your settings using .



6.3.8.3 **Setting the upper scale value for 10 V of the analog output**

You can set which leakage rates are represented by 10 V on the analog output. This setting only comes into effect when "leakage rate linear" is selected for the configuration of the analog output.

- 1 Select " > Setup > Interfaces > I/O Module > Analog Scale".
- 2 To set the upper scale value, enter a numerical value between, for example, 10 g/a and 1000 g/a using the buttons.
- 3 Confirm your settings using .

6.3.8.4 **Setting up the I/O module protocol**

Refer to "Interface description HLD6000 (doc. no. kins44e1-a)" for switching between "ASCII", "LD" (Leak Detection), "Normal" and "Simple" formats.

- 1 Select " > Setup > Interfaces > I/O Module > Protocol".
- 2 Select between "ASCII", "LD", "Normal", and "Simple".
- 3 Confirm your settings using .

6.3.8.5 **Configuring PLC outputs**



You can set which function should be displayed on the PLC output.

- 1 Select " > Setup > Interfaces > I/O Module > PLC Outputs".
- 2 Select one of the 8 PLC outputs and allocate a function to it:
 - Setpoint 1 or 2
 - CAL internal active
 - CAL external active
 - PROOF active
 - Warning
 - Error
 - CAL or PROOF active
 - CAL request
 - Run up
 - Sniffer button
 - Light barrier



- Measuring
 - Standby
 - Sniffer is closed
 - Error or warning
 - CAL internal possible
- 3 Choose between "Normal" or "Inverse".
 - 4 Assign additional PLC outputs to a function if necessary.
 - 5 Confirm your selection using .

6.3.8.6 Configuring PLC inputs

You can set which function is carried out by a signal on the PLC input.

- 1 Select " > Setup > Interfaces > I/O Module > PLC Inputs".
- 2 Select one of the 10 PLC inputs and allocate a function to it:
 - No function
 - CAL extern
 - Start
 - Stop
 - Delete
 - Trigger selection (to use this function, switch the "Sniffer button configuration" to "Off", see "6.4.2 Setting up the sniffer probe", page 42.)
- 3 Choose between "Normal" or "Inverse".
- 4 Assign additional PLC inputs to a function if necessary.
- 5 Confirm your selection using .

6.3.8.7 Setting the interface unit

- 1 Select " > Setup > Interfaces > I/O Module > Units".
- 2 Select the unit for the output of leakage rates from the following options:
 - g/a (factory setting)
 - lb/yr
 - mbar l/s
 - oz/yr
 - Pa m³/s
- 3 Confirm your selection using .

6.3.9 Bus module

Introduction information:

- Instruction manual BM1000, bus module, document no. jiqb10.
- File "BM1000-Profinet-Configuration.pdf"
- File "ABCC-DPV1-1-32.pdf" (Anybus®-CompactCom PROFIBUS DP-V1)

6.3.9.1 Creating a connection between the device and the bus module

To create the connection between the bus module and the device, do the following:

- 1 Switch the device off.
- 2 Connect the INFICON bus module with a data cable to the M12 socket on the rear of the device, see "Fig. 2: Rear view", page 15.
- 3 Switch on the HLD6000.
- 4 Select "⚙️ > Setup > Interfaces > Device Selection".
- 5 Select "Bus" as the module at M12 connector.
- 6 Confirm your settings using ⏴.

6.3.9.2 Setting a bus module address

You can set the setpoint for the field bus address. With PROFIBUS® this is the node address.

- 1 Select "⚙️ > Setup > Interfaces > Bus module > Address".
- 2 Use the keyboard shown for your entries.
- 3 Confirm your settings using ⏴.
The value set is first carried over when restarting the HLD6000. To do this, switch the power supply off and back on.

6.3.10 Setup scope of error messages

You can set up the scope within which error messages are shown on the display during operation of the device. This can be set up separately for the supervisor and the operator.

- 1 Select "⚙️ > Setup > Advanced setup > Error information".
- 2 Under "Error information operator" or "Error information supervisor" choose between
 - No.
 - No. and text
 - No., text and info
- 3 Confirm your settings using ⏴.

6.3.11 Access to the settings



Role concept

- If you are logged in as a "supervisor" then you can change all settings available in the device, protect against changes and check test objects for leaks.
- If you are logged in as an "operator" then you can change settings as far as is authorized and check test objects for leaks. The scope of the adjustment options depends, on the one hand, on the factory settings and on the other hand whether the "supervisor" has

assigned or withdrawn permissions. When individual parameters are grayed out then no changes can be made.

- For a list of the preset parameter access controls, see ["Table 4: Factory settings for access authorization", page 20.](#)

The active role can be seen on the menu bar on the touchscreen:

As "operator" you see the symbol , as "supervisor" you see the symbol .

Starting procedure in delivery condition

A stored PIN number is assessed during the starting procedure.

The PIN "0000" is preset in delivery condition. This means the device is started with a log-in as "supervisor".

Starting procedure after assigning the PIN

The "supervisor" can protect existing settings by inputting a PIN number. After restarting the device it restarts with a log-in as "operator". This can be switched over to "supervisor" only when the correct PIN is entered.

6.3.11.1 Protecting settings via PIN assign







You are logged in as a "supervisor" .

- 1 Select  > Access Ctrl. > Supervisor > PIN Assign".
- 2 Enter a 4-digit number of your choice as the PIN.
So that your settings are protected, do not select "0000", see ["Starting procedure in delivery condition", page 40.](#)

To cancel protection again, enter "0000" as the PIN (factory setting).



If you have forgotten the supervisor PIN, then please contact the INFICON service team. Further information can be found from the help text when entering the PIN.

6.3.11.2 Switching between "supervisor" and "operator" modes

- ▶ To change from "supervisor"  to "operator"  select  > Access Ctrl. > Operator" . When a PIN is stored then you can also switch the device on and off.
- ▶ To change from "operator"  to the role of "supervisor"  then select  > Access Ctrl. > Supervisor". Enter the PIN which is stored for logging in as "supervisor".



6.3.11.3 Changing parameter access controls



You are logged in as a "supervisor" .

- 1 Select  > Parameter > Parameter access level".
A list of all parameters is shown including the assignments to "supervisor" and "operator".
- 2 To change a parameter assignment in the list illustrated, press on an entry when logged in as "supervisor".
Pressing on an entry changes the shown assignment between "supervisor" and "operator".
- 3 To reject the change, press on  or to confirm, press on .

With regards to the factory settings, see ["Table 4: Factory settings for access authorization", page 20.](#)

6.3.12 Save parameters

You can be logged in as a "supervisor"  or as an "operator" . Regardless of access rights, you can select parameters and save them on a USB stick.



- 1 Connect a USB stick with the USB port on the device.
- 2 Select " > Parameter > Save".
- 3 Either select all parameters or just individual parameters.
- 4 Confirm your selection using .

If necessary, the saved parameters can be transferred back to the device, see "6.3.13 Loading parameters", page 41.

6.3.13 Loading parameters



As "supervisor"  you can transfer all parameters belonging to the selected parameter file from the USB stick onto the device.

If you are logged in as an "operator"  then only those parameters which you are authorized to access are transferred from the selected parameter file to the device.

- 1 Connect a USB stick with the USB port on the device.
- 2 Select " > Parameter > Load".
- 3 Select a parameter file.
- 4 Confirm with .

6.3.14 Switching the "Screenshot" function on or off

To allow screenshots to be saved on a USB stick, enable the "Screenshot" function. You can use screenshots when contacting INFICON service.

- 1 Insert a FAT formatted USB stick with the USB port on the device.
- 2 Select " > Display settings > Screenshot".
- 3 Under "Screenshot with probe key" choose between "On" or "Off".
- 4 Confirm with .

For further information on saving screenshots see "6.4.7 Measuring", page 48.

6.4 Settings for the measurements

6.4.1 Setting setpoints

By setting setpoints you can define which quantity of escaping gas you want maximum tolerance for a test object.

One setpoint

You only set setpoint 1.
The button on the sniffer probe is not required to switch from one setpoint to another setpoint.

Two setpoints

Alternatively you can set setpoint 1 and setpoint 2 and when measuring toggle between both setpoints by pressing the button on the sniffer line.

You can only use setpoint 2 when the function for the sniffer line button is set to "Setpoint" in the settings, see "6.4.2 Setting up the sniffer probe", page 42.

For example:



To identify leaks, measure a test object sensitivity with low setpoint without pressing the button on the sniffer line.

If the device reports a leak, press the button on the sniffer line to measure the test object with the higher setpoint 2.

Setting ranges

Table 8: Setting range for setpoints

Unit	Lower setpoint	Lower setpoint SMART Sniffer line	Upper setpoint
g/a	1.0	0.5	99.0
mbar l/s ⁻¹	4 x 10 ⁻⁶	4 x 10 ⁻⁶	3.9 x 10 ⁻⁴
lb/yr	2 x 10 ⁻³	1	1 x 10 ⁻¹
oz/yr	0.04	0.02	1.76
Pa m ³ x s ⁻¹	4 x 10 ⁻⁷	4 x 10 ⁻⁷	3.9 x 10 ⁻⁵

- ▶ To set setpoints, select " > Setpoints > Leakage Rate Setpoint 1" or " > Setpoints > Leakage Rate Setpoint 2".

6.4.2 Setting up the sniffer probe

Key configuration

You can change between both setpoints via the button on the sniffer probe. This function can be switched either on or off: "Setpoint" or "Off".

Regarding setpoints see "6.4.1 Setting setpoints", page 42.

To replace the setpoint see "6.4.7 Measuring", page 48.

Light brightness

You can adjust the general brightness of the light of the sniffer probe in several steps.

Light Alarm function

Light when exceeding the setpoint. There are 3 options regarding the settings: Off, Brighter, Flashing.

- ▶ To set up the button function and light on the sniffer probe, select " > Set Up > Sniffer Line".

6.4.3 Setting up an alarm profile for setpoints

You can set up how you are acoustically made aware of measurement results during measurements.

Table 9: Features of the alarm profile

Requirements	Alarm profile Pinpoint	Alarm profile Setpoint	Alarm profile Trigger
	Recommended, for precise leak localization. The sound of the acoustic signal changes its frequency within a window around the setpoint.	The pitch level is proportional to the leakage rate.	If the selected setpoint is exceeded, then a two-pitch signal is issued.
Setpoint undercut	–	No sound	No sound
Setpoint exceeded	–	Signal tone with increasing frequency	Two-tone signal
Acoustic tracing of the measurement result	< 1/10 Setpoint: low frequency	–	–
	> 1/10 threshold value up to 10 × threshold value: rising frequency		
	> 10 × threshold value: High frequency		

- ▶ To set the alarm, select "⚙️ > Setpoints > Setpoint Alarm".

6.4.4 Setting up the gas for the SMART sniffer line

If you use a SMART sniffer line then several different gases can be sniffed. R22, R32, R134a, R404A, R407C, R410A, R1234yf and R1234ze gases are preset. In addition you can also choose 3 further gases from a list of gases that the device can verify.

Preset gases

- ▶ To select one of the gases that the device can sniff, select "⚙️ > Gas" and insert the desired gas.
 - If you have internally calibrated a preset gas and are switching over to another preset gas then recalibration is not required.
 - If you have externally calibrated a preset gas and are switching over to another preset gas then the device prompts you to calibrate.

User-defined gases

You can set up 3 additional gases of your choice, provided that these can be verified by the device. You can obtain more information about this from INFICON by request.

- ▶ To create a name of your choice for another gas, choose "⚙️ > Setup > Advanced setup > SMART user gases" and under <Name user gas 1> or <Name user gas 2> or <Name user gas 3> enter the desired name.

There are various options available for setting up.

Option 1:

You can calibrate the device with the aid of an external calibration leak with the desired gas and then carry out your measurements.

- 1 Select "⚙️ > Gas" and enter your desired user-defined gas.
The calibration factor should be set to "0" in the settings window under "Factor user gas".
- 2 Then calibration with the external calibration leak can be carried out, see "6.4.6.3 Calibration with an external calibration leak", page 46.

Option 2:

Alternatively, you can calibrate the device for the desired gas without accessing an external calibration leak with the desired gas:

The internal COOL-Check with coolant R134a is used as a basis and the discrepancy for the desired gas is automatically corrected by means of an adjustable calibration factor on the device.

For most gases the required calibration factors from INFICON can be used.

- 1 Select "⚙️ > Gas" and enter your desired user-defined gas.
- 2 In the setting window under "Factor user gas" enter the calibration factor which you received from INFICON.
When carrying out the unit calculation of user gases in mbar l/s and Pa m³/s an average molecular weight of 96 is assumed. If this is not accurate enough then calibrate externally using a test leakage value in the corresponding unit.
- 3 Then calibration with the internal COOL-Check can be carried out, see "6.4.6.2 Calibration with an internal COOL-Check", page 45.

6.4.5 Verifying R290 with the sniffer line for R600a/R290

It is also possible to verify R290 (propane) with a sniffer line for R600a.
The measuring sensitivity for R290 is approx. 7% higher than for R600a.

You have the option of

- ▶ calibrating with an external calibration leak with R290 to avoid overly high displays or
- ▶ calibrating with an external calibration leak with R600a.
If sniffing with the R290 then the displayed measurement results will be 7% too high. It is therefore recommended to also set the setpoint 7% higher than for sniffing with the R600a.

i	<p>If the calibration has been carried out in g/a, for example, after switching to the units mbar l/s or Pa m³/s, the measured values are inaccurate. When converting units from R600a to R290, an average molecular weight of 51 g/mol is assumed for both gases.</p> <ul style="list-style-type: none"> ▶ For the greatest possible accuracy, you should therefore calibrate directly in the desired unit. Details of leakage rates in various units can be found in the acceptance test certificate for the calibrated leak.
----------	---

6.4.6 Calibration

6.4.6.1 Time and type of calibration

The device should be calibrated daily and after every operator change. Calibration is also required after the following actions:

- Switching the sniffer line
- Switching the sniffer probe

- Switching between the gases
- Request for calibration by the system

If you insert a COOL-Check calibration leak then this is the easiest method to calibrate the device. The COOL-Check is integrated into the base plate of the device as described in the separate COOL-Check installation manual.

The leakage rate of the COOL-Check is temperature compensated and thus makes the accuracy required for calibration possible. The COOL-Check calibration leak contains R134a.

The most accurate calibration is achieved with the external calibration leak. The calibration leaks apply to one gas each and are temperature resistant.

When using a sniffer line for R744 (CO₂) or a sniffer line for R600a/R290 then calibration can only take place with one external calibration leak.

The gas that leaks from the calibration leak is carried away by strong air currents. Keep this in mind when, for example, a fan blower is standing in your surroundings. Strong air currents provide false results when calibrating.

If you have assembled an extension hose for the sniffer tip then before calibrating with the internal COOL-Check insert a centering ring to make the calibration opening on the device smaller see "5.3.4 Using an extension hose for a sniffer tip", page 26. The centering ring is contained in the shipment of a set with extension hoses for the sniffer tip.

Calibrate the device at least five minutes after switching it on. After the warm-up phase it is ensured that the device calibrates optimally.

6.4.6.2 Calibration with an internal COOL-Check

A COOL-Check has a life of about 2 years. It is announced on the basic unit that the life of the COOL-Check is running short 3 months before this time has elapsed.

For this reason never keep a supply of COOL-Checks. Store the COOL-Check in a cool, dry place.



Fig. 13: Display when calibrating internally

- 1 Switch to measurement display
- 2 There are 2 options:
 - If you are prompted to calibrate then lead the sniffer tip into the calibration opening at the front of the basic unit. Calibration takes place automatically.

- If you are not prompted to calibrate, but wish to do so anyway then lead the sniffer tip into the calibration opening at the front of the basic unit whilst holding down the button on the sniffer probe.
Calibration takes place automatically. If the button on the sniffer probe is not pressed then the calibration is only checked see "6.4.6.4 Checking the calibration with an internal COOL-Check", page 47.

3 Keep the sniffer line still and straight during calibration.

The display shows individual calibration phases and informs you whether or not calibration was successful.

6.4.6.3 Calibration with an external calibration leak

The gas that leaks from the calibration leak is carried away by strong air currents. Keep this in mind when, for example, a fan blower is standing in your surroundings. Strong air currents provide false results when calibrating.

- 1 Select "⚙️ > Setup > Calibration leak external".
- 2 Enter the leakage rate to calibrate for the tracer gas and confirm using ⏴. Details of leakage rates in various units can be found in the acceptance test certificate for the calibrated leak.
Alternatively, set the desired leakage rate via the calibration display on the touchscreen, see "Fig. 14: Display for external calibration", page 46 and step 5.
- 3 Switch to measurement screen 👁️.
- 4 For external calibration, select 🎯.

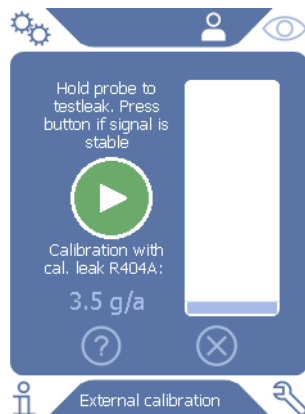

Fig. 14: Display for external calibration

- 5 If you wish to change the displayed leakage rate (in this example: 3.5 g/a) then this can be done after pressing a finger on this value. For more information, see "6.2.1 Structure of the touchscreen", page 30.
- 6 Hold the sniffer tip to the opening of the external test leak and start the calibration by pressing the green button on the touch screen or alternatively by pressing the button on the sniffer probe.
- 7 Hold the sniffer line still and straight as long as the device is calibrating.

The display shows individual calibration phases and informs you whether or not calibration was successful.

6.4.6.4 *Checking the calibration with an internal COOL-Check*

The calibration can also be checked without changing calibration values. You can find out whether calibration is necessary.

- 1** Switch to measurement display.
 - 2** Lead the sniffer tip into the calibration opening on the front of the basic unit without pressing the button on the sniffer probe.
 - 3** Hold the sniffer line still and straight as long as the device is checking the calibration. A message appears stating whether the calibration is OK or whether the device requires recalibration.
- ▶ When the corresponding message appears on the measurement screen then press the button on the sniffer probe to calibrate.

6.4.7 Measuring

 WARNING

Risk of electric shock

Electrical voltages can be transmitted via the sniffer probe and cause damage to property or personal injury.

- ▶ Do not touch live parts with the sniffer probe.
- ▶ Disconnect electrically operated test objects from the mains before starting the leak test and secure them against being restarted without authorization.

 WARNING

Risk of eye damage

LEDs generate a bundled light that can damage your eyes.

- ▶ Do not look into the LEDs from a short distance or for longer periods of time.

 CAUTION

Risk of electric shock

Sucked up liquids can trigger short circuits and cause property damage or personal injury.

- ▶ Do not suck up liquids into the device.
- ▶ Use the water conservation tip in humid environments.

Requirements

- A sniffer line is connected to the basic unit.
- The device has started up and is warmed up, [see "6.1 Switching on the device", page 29](#).
- The device is calibrated, [see "6.4.6.1 Time and type of calibration", page 44](#).
- You have configured the measurement settings required for your measurement, [see "6.4 Settings for the measurements", page 42](#).
- If you check areas which are difficult to reach then you can also insert an extended and, if desired, flexible sniffer tip, [see "5.3.3 Using flexible sniffer tips", page 25](#).
- Alternatively, you can attach an extension hose to the sniffer tip at the front, [see "5.3.4 Using an extension hose for a sniffer tip", page 26](#).

Procedure

- ▶ Hold the sniffer tip close to the potential leak. The tip must touch the test object.
- ▶ If you want to test a weld seam or similar, you must guide the tip along the path at a speed of less than 2.5 cm/s.
- ▶ When you check a spot, hold the sniffer line to it for least 1 second.
- ▶ If you have activated the button function on the sniffer probe, [see "6.4.2 Setting up the sniffer probe", page 42](#), then you have the following options:

- If the button is not pressed on the sniffer probe: Measurement takes setpoint 1 into consideration,
- If the button is pressed on the sniffer probe: Measurement takes setpoint 2 into consideration.

i	<p>If you have activated the "Screenshot" function, see "6.3.14 Switching the "Screenshot" function on or off", page 41, save a screenshot by pressing the button on the sniffer probe.</p> <p>If the button function is enabled on the sniffer probe at this time, the screenshot is also saved when switching to setpoint 2.</p>
----------	--

If there is a leak, it will be reported in the displays with LEDs in the handle and - depending on your settings - also accompanied by an acoustic signal.

6.4.8 Measured data



6.4.8.1 Recording measured data

You can save measured data as files in TXT format. The device creates a new TXT file every hour.



There is approx. 16 MB of free internal memory available. This is sufficient when setting up a 500 ms recording interval for approx. 24 hours.

Alternatively, measured data can be saved on a USB stick up to 32 GB (formatted in the FAT file system).

Starting recording

- 1 Select  > Recorder > Recorder Settings".
Alternatively, when on the touchscreen select the button .
- 2 Select from the following settings:
"Memory location": "USB" or "Internal"
"Record interval": "100 ms", "200 ms", "500 ms", "1 s", "2 s" or "5s"
- 3 If "USB" is selected as the memory location then connect a USB stick with the USB port on the device.
- 4 Select the "On" button under "Data Record".
- 5 Start data recording by selecting the button .
If the device is switched off or the USB stick is removed from the USB memory location without finishing the data record then the data for the current hour being recorded is lost.

Stopping recording

- 1 Select  > Recorder > Recorder Settings".
Alternatively, when on the touchscreen select the button .
- 2 Press the "Off" button under "Data Record".
- 3 Stop data recording by selecting the button .

6.4.8.2 Evaluating measured data

A file with measured date is constructed as follows:

For example

```
// Record file: \L0000001.txt
// Created by HLD6000CU V0.11.02.18681
// HLD6000CU Ser.-No.: 0000000000
// HLD6000 Ser.-No.: 0000000000
// HLD6000MB V0.22.06(1.04.00)
// Probe V1.00
// Probe Ser.-No.: HLD5000 probe
// Probe Type: SMART (R134A)
// IO1000 V0.05.00(0.02.02)
// IO1000 Ser.-No.: 0000000000
// BM1000 not connected
// Start time: 23.06.2014 08:58:25
Time Leakrate[g/a] Status
0.0 1.82E-02 MEASURE
0.5 1.82E-02 MEASURE
1.0 4.16E-03 MEASURE
1.5 1.29E-02 MEASURE
2.0 0.00E+00 MEASURE
2.5 1.02E-02 MEASURE
3.0 1.75E-03 MEASURE
3.5 3.43E-03 MEASURE
4.0 3.43E-03 MEASURE
4.5 0.00E+00 MEASURE
5.0 8.20E-03 MEASURE
5.5 1.71E-02 MEASURE
6.0 1.52E-02 MEASURE
```

In the example shown the data record started on 06/23/2014 at 8:58:25. From this start time onwards a measurement result was recorded every 500 milliseconds.

1.82E-02 means 1.82×10^{-2} as the leakage rate per year.

The following status entries are possible:

Status entry	Meaning
UNKNOWN	Unknown, as, e.g., there is no communication
RUNUP	Run up
STANDBY	Standby
MEASURE	Measuring
ERROR (xxx)	Error (error number)
WARNING (xxx)	Warning (warning number)
CAL	Calibration

6.4.8.3 Transferring measured data from the internal memory to a USB stick

It is possible to transfer measured data on the internal memory to a connected USB stick.

- 1 Connect a USB stick with the USB port on the device.
- 2 Select "⚙️ > Recorder > Copy".
- 3 Select the files you wish to copy.
- 4 Confirm your selection using ⏹.

6.4.8.4 Deleting measurement data

If the internal memory has no more available space for the data record then measured data can be deleted.

- 1 Select "⚙️ > Recorder > Delete".
- 2 Select the files you wish to delete.
- 3 Confirm your selection using ☑️.

6.5 Standby

The device switches to idle mode when you select the ⏸️ button in the measurement display of the device.

Either pressing the ⏸️ button or pressing the button on the sniffer probe will reactivate the device.

If the device was in standby mode for more than 25 seconds, you can activate the device by moving the sniffer line.

6.6 Diagnosis

Active warnings

To show a list of current warnings, select "🔍 > Active Warnings".

Service

The Service menu is password-protected. You can configure settings in the Service menu only after completing a special training course from the INFICON service department.

Histories

To receive information on errors and warnings which have occurred, select "🔍 > Histories > Error And Warning History".

To receive information regarding calibrations which were carried out, select the button "🔍 > Histories > Calibration History".

Update

To initiate an update, select "🔍 > Update". For further information on this process see ["6.8 Updating the software", page 53](#).

6.7 Calling up information about the device

It is possible to call up information regarding the parameters set and the operating modes of the device.

- 1 Select the navigation button ⓘ.
- 2 Make a selection by pressing one of the following buttons:
 - Basic unit
 - COOL-Check
 - I/O module
 - Parameter list
 - Sniffer line
 - Operating unit
 - Bus module



The stored device-specific information is displayed.

- 3 View the desired information. These include, for example
 - under "Basic Unit" there is information regarding the software version, the serial number of the device, the operating hours and the interior housing temperature,
 - under "COOL-Check" there is information regarding the leakage rate depending on temperature and on the remaining time of use available,
 - under "Sniffer Line" there is information regarding the software version, the serial number and the gas used,
 - under "Operating Unit" there is information regarding the operating system and the software version.
- 4 To view all information, press on the page numbers displayed below.

6.7.1 Parameter list



It is possible to display all settings for the device. For changes the necessary permissions are required, see "6.3.11 Access to the settings", page 39.

With the aid of the parameter list several changes can be carried out in one area without navigating through various menu trees, see "10.2 Menu trees", page 70.

- 1 To create the parameter list, select " > Parameter List". Alternatively, select " > Parameters > Parameter List".

The following parameters are displayed:

- Analog output upper limit see "6.3.8.3 Setting the upper scale value for 10 V of the analog output", page 37,
- Display off after, see "6.3.5 Setting the display", page 35,
- Display brightness, see "6.3.5 Setting the display", page 35,
- Diagram maximum value (log.), see "6.3.5 Setting the display", page 35,
- Diagram maximum value (lin.), see "6.3.5 Setting the display", page 35,
- Display upper limit (lin.), see "6.3.5 Setting the display", page 35,
- Display upper limit (log.), see "6.3.5 Setting the display", page 35,
- Display unit leakage rate, see "6.3.5 Setting the display", page 35,
- Auto scale, see "6.3.5 Setting the display", page 35,
- Screen tap sound, see "6.3.3 Adjust volume", page 34,
- Bus module address, see "6.3.9.2 Setting a bus module address", page 39,
- Data record, see "6.4.8.1 Recording measured data", page 49,
- Date, see "6.3.2 Setting date and time", page 34,
- Diagram of the leakage rate, see "6.3.5 Setting the display", page 35,
- Factor user gas 1, see "6.4.4 Setting up the gas for the SMART sniffer line", page 43,
- Factor user gas 2, see "6.4.4 Setting up the gas for the SMART sniffer line", page 43,
- Factor user gas 3, see "6.4.4 Setting up the gas for the SMART sniffer line", page 43,
- Error information operator, see "6.3.10 Setup scope of error messages", page 39,
- Error information supervisor, see "6.3.10 Setup scope of error messages", page 39,
- Filter change request, see "6.3.7 Setting the filter change request", page 36,
- Filter change interval, see "6.3.7 Setting the filter change request", page 36,
- Gas of R600a sniffer line, see "6.4.5 Verifying R290 with the sniffer line for R600a/ R290", page 44,
- Gas of SMART sniffer line, see "6.4.4 Setting up the gas for the SMART sniffer line", page 43,

- I/O module protocol, see "6.3.8 I/O module", page 36,
 - Auto standby interval, see "6.3.4 Setting auto standby", page 35,
 - Calibration request interval, see "6.3.6 Set time interval for calibration request", page 36,
 - Calibration factor, see "6.4.6 Calibration", page 44 (can be changed by the service team),
 - Config. Analog output 1 - 2, see "6.3.8.2 Configuring analog outputs", page 37,
 - Configuration PLC Outputs 1 - 8, see "6.3.8.5 Configuring PLC outputs", page 37,
 - Configuration PLC Inputs 1 - 10, see "6.3.8.6 Configuring PLC inputs", page 38,
 - Volume, see "6.3.3 Adjust volume", page 34,
 - Leakage rate setpoint 1, see "6.4.1 Setting setpoints", page 42,
 - Leakage rate setpoint 2, see "6.4.1 Setting setpoints", page 42,
 - Show measured value, see "6.3.5 Setting the display", page 35,
 - Module at M12 connector, see "6.3.8 I/O module", page 36,
 - Name user gas 1, see "6.4.4 Setting up the gas for the SMART sniffer line", page 43,
 - Name user gas 2, see "6.4.4 Setting up the gas for the SMART sniffer line", page 43,
 - Name user gas 3, see "6.4.4 Setting up the gas for the SMART sniffer line", page 43,
 - Phase, see "6.4.6 Calibration", page 44 (can be changed by the service team),
 - Calibration leak external, see "6.4.6.3 Calibration with an external calibration leak", page 46,
 - Interface unit leakage rate, see "6.3.8.7 Setting the interface unit", page 38,
 - Sniffer light alarm configuration, see "6.4.2 Setting up the sniffer probe", page 42,
 - Sniffer light brightness, see "6.4.2 Setting up the sniffer probe", page 42,
 - Probe key configuration, see "6.4.2 Setting up the sniffer probe", page 42,
 - Setpoint audio alarm, see "6.4.3 Setting up an alarm profile for setpoints", page 43,
 - Screenshot with probe key, see "6.3.14 Switching the "Screenshot" function on or off", page 41,
 - Record interval, see "6.4.8 Measured data", page 49,
 - Memory location, see "6.4.8 Measured data", page 49,
 - Language, see "6.3.1 Setting the language", page 34,
 - Time, see "6.3.2 Setting date and time", page 34,
 - Show warnings (can only be changed by Service)
 - Value axis decades, see "6.3.5 Setting the display", page 35,
 - Value axis grid, see "6.3.5 Setting the display", page 35,
 - Time axis scale, see "6.3.5 Setting the display", page 35,
- 2 To change individual parameters, press on an entry on the touchscreen.
- 3 Either confirm changes with  or reject them with the  button.

6.8 Updating the software

Software updates from INFICON are installed with the aid of a USB stick. The update function of the device can be found under "  > Update".

An update is possible,

- if one or several updates are available on the USB stick, but only one update per type at most (basic unit, operating unit, sniffer line, I/O module),

- if in the case of the "sniffer line" or the "I/O module" these parts are also connected free of disturbances and have an update function.

The corresponding buttons in the update menu such as "Basic Unit", "Operating Unit", "Sniffer Line" and "I/O Module" are active and can be activated individually. Inactive buttons can be recognized as they are in gray.

NOTICE

Data loss due to an aborted connection

- ▶ Do not switch off the device and do not remove the USB stick whilst the software is being updated.

- ▶ Switch the device off and back on after a software update has taken place.

6.8.1 Updating the software of the basic unit

The software is included in the file named Flash_HLD6000_Main_Vxx.xx.xxx.bin.

- 1 Copy the file into the main directory of a USB stick.
- 2 Connect the USB stick with the USB port on the device.
- 3 Select "☰ > Update > Basic Unit".
The display shows information on the current and the new software as well as on the current boot loader.
- 4 Check the version information.
- 5 Select the "Start" button to start the update.
Do not switch off the device and do not remove the USB stick whilst the software is being updated!
- 6 Follow the instructions on the touchscreen and wait until the update is complete.
- 7 If the system displays warning 104 or 106, close it with ☒.

6.8.2 Updating the software of the operating unit

The software is included in 2 files named HLD6000CU_IFC_Vx.xx.xx.exe and HLD6000CU_IFC_Vx.xx.xx.button.

- 1 Copy the files into the main directory of a USB stick.
- 2 Connect the USB stick with the USB port on the device.
- 3 Select "☰ > Update > Operating Unit".
The display shows information on the current and the new software version.
- 4 Check the version information.
- 5 Select the "Start" button to start the update.
Do not switch off the device and do not remove the USB stick whilst the software is being updated!
- 6 Follow the instructions on the touchscreen and wait until the update is complete.

6.8.3 Updating the software of the sniffer line

The software on the HLD6000 sniffer line can be updated from the basic unit provided that the sniffer line is connected and works perfectly.

The software is included in the file named "Flash_HLD6000_Probe_Vxx.xx.xxx.bin".

- 1 Copy the file into the main directory of a USB stick.
- 2 Connect the USB stick with the USB port on the device.
- 3 Select "☰ > Update > Sniffer Line".
The display shows information on the current and the new software as well as on the current boot loader.
- 4 Check the version information.
- 5 Select the "Start" button to start the update.
Do not switch off the device and do not remove the USB stick whilst the software is being updated!

6.8.4 Updating the software of the I/O module

The software on the I/O module can be updated from the HLD6000 provided that the I/O module is connected and works perfectly.

The software is included in the file named "Flash_IO1000_Vxx.xx.xxx.bin".

- 1 Copy the file into the main directory of a USB stick.
- 2 Connect the USB stick with the USB port on the device.
- 3 Select "☰ > Update > I/O Module".
The display shows information on the current and the new software as well as on the current boot loader.
- 4 Check the version information.
- 5 Select the "Start" button to start the update.
Do not switch off the device and do not remove the USB stick whilst the software is being updated!
- 6 Follow the instructions on the touchscreen and wait until the update is complete.
The following tips are shown after selecting the "Start" button on the touchscreen:
 - Connect and switch on the IO1000.
 - Activate boot mode (switch DIP S2.3 on and off once).
 - When the STATUS LED flashes green, press OK.

6.9 Switching off the device

You can switch off the device at any time with the mains plug. The parameters set in the device remain saved.

7 Warning and error messages

During operation, the display shows information that helps you operate the device. Measurements are displayed along with current device modes, operating instructions as well as warnings and error messages.

The device is equipped with extensive self-diagnostic functions. If the electronics detects a faulty state, the device will show this as far as possible on the display and will interrupt operation when necessary.

Warnings

Warnings warn of device modes that can impair the accuracy of measurements. Operation of the device is not interrupted.

Pressing the "X" button acknowledges the warning.

Error messages

Errors are events that the device cannot correct itself and that force interruption of its operation. The error message consists of a number and a descriptive text.

If you have eliminated the cause of the error, then start operation again by pressing the button .

The following table displays all the warnings and error messages. It states possible causes for the malfunction and instructions on troubleshooting.

Table 10: Warning and error messages

No.	Message	Possible error sources	Troubleshooting
1xx system error			
W102	Timeout of EEPROM basic unit	Basic unit EEPROM defective.	Please contact INFICON customer service.
W104	One EEPROM parameter initialized	<ul style="list-style-type: none"> – A new parameter was introduced by a software update. – If the message occurs constantly during running up, the EEPROM on the basic unit is defective. 	<ul style="list-style-type: none"> – Confirm the warning. – Check whether the factory settings correspond with the new parameter of your application. – Please contact INFICON customer service.
W106	EEPROM parameter initializing	<ul style="list-style-type: none"> – A software update introduced new parameters. – The motherboard was replaced. – If the message occurs constantly during running up, the EEPROM on the basic unit is defective. 	<ul style="list-style-type: none"> – Confirm the warning. – Check whether the settings correspond with your application. – Please contact INFICON customer service
W110	Clock not set	Clock jumper not set, battery empty or clock defective.	Please contact INFICON customer service.
W122	No answer from bus module	BUS module disconnected.	Check the connection to the BUS module.
W125	I/O module disconnected	I/O module is disconnected.	Check the connection to the I/O module.
W126	Protocol not supported by I/O module software	The I/O module software does not support the selected HLD5000 protocol.	Make a software update of the I/O module to a newer version.
W127	Wrong bootloader version	The boot loader software is not compatible with the application.	Please contact INFICON customer service.
E130	The sniffer line is not connected	The sniffer line can not be addressed by the basic unit.	<ul style="list-style-type: none"> – Check the connection of the sniffer line with the basic unit (disconnect and reconnect; if possible try a different sniffer line). – If the problem persists, please contact INFICON customer service.
E131	Wrong parameter in the sniffer line	The parameters stored in the sniffer line are wrong.	Please contact INFICON customer service.
E132	Unsupported old sniffer line	An old sniffer line is connected which is not supported.	Use a current sniffer line.

Table 10: Warning and error messages (Contin.)

No.	Message	Possible error sources	Troubleshooting
E133	EEPROM failure sniffer line	The EEPROM of the sniffer line is defective	Please contact INFICON customer service.
E134	Protocol error while communicating with the sniffer line	The interface to the sniffer line is not working correctly.	<ul style="list-style-type: none"> – Check the connection of the sniffer line with the basic unit (disconnect and reconnect; if possible try a different sniffer line). – If the problem persists, please contact INFICON customer service.
E135	Check sum error while communicating with sniffer line	<ul style="list-style-type: none"> – The interface to the sniffer line does not function reliably. – Possible electrical sources of disturbance close by. 	<ul style="list-style-type: none"> – Check the connection of the sniffer line with the basic unit (disconnect and reconnect; if possible try a different sniffer line). – Eliminate sources of disturbance – If the problem persists, please contact INFICON customer service.
E136	No answer from sniffer line	The interface to the sniffer line is not working correctly.	<ul style="list-style-type: none"> – Check the connection of the sniffer line with the basic unit (disconnect and reconnect; if possible try a different sniffer line). – If the problem persists, please contact INFICON customer service.
E137	Sniffer line reset	<ul style="list-style-type: none"> – The sniffer line has reset itself. – Possible electrical sources of disturbance close by. – The sniffer line is not connected correctly. 	<ul style="list-style-type: none"> – Eliminate sources of disturbance – Check the connection of the sniffer line with the basic unit (disconnect and reconnect; if possible try a different sniffer line). – If the problem persists, please contact INFICON customer service.
E138	Check sum error in sniffer line EEPROM	The EEPROM of the sniffer line has incorrect data or is defective.	Please contact INFICON customer service.
E139	Sniffer line EEPROM is empty	The EEPROM of the sniffer line has no data or is defective.	Please contact INFICON customer service.
W140	Acceleration of the probe was permanently too high within the last 5 minutes	<ul style="list-style-type: none"> – The sniffer line is not lying still. – Sniffer line defective. 	<ul style="list-style-type: none"> – Place the sniffer line on a steadier surface. – Please contact INFICON customer service.
W151	No communication with operating unit	Internal connection problems between the basic unit and the operating unit.	Please contact INFICON customer service.
W163	COOL-Check is not connected	COOL-Check not connected or not properly connected.	<ul style="list-style-type: none"> – Connect a COOL-Check, otherwise confirm the warning and calibrate externally. – Check the COOL-Check connection.
W164	Checksum error in COOL-Check	<ul style="list-style-type: none"> – The COOL-Check is not connected correctly. – The COOL-Check or the basic unit is defective. 	<ul style="list-style-type: none"> – Check the COOL-Check connection. – Check the connection of the COOL-Check to basic unit (separate and reconnect; try another COOL-Check, if possible). – If the problem persists, please contact INFICON customer service.

Table 10: Warning and error messages (Contin.)

No.	Message	Possible error sources	Troubleshooting
E165	Timeout of EEPROM COOL-Check	<ul style="list-style-type: none"> – The COOL-Check is not connected correctly. – The COOL-Check or the basic unit is defective. 	<ul style="list-style-type: none"> – Check the COOL-Check connection – Check the connection of the COOL-Check to basic unit (separate and reconnect; try another COOL-Check, if possible). – If the problem persists, please contact INFICON customer service.
W166	Audio amplifier is faulty	Fault in the internal audio amplifier	Please contact INFICON customer service.
2xx voltage error			
W220	Voltage +24V out of range	<ul style="list-style-type: none"> – Line error on the M12 socket or the module connected there. – Internal defect. 	<ul style="list-style-type: none"> – Check the connections. – Please contact INFICON customer service.
W230	Voltage +3.3V out of range	Internal defect.	Please contact INFICON customer service.
W240	Voltage +12V out of range	<ul style="list-style-type: none"> – Sniffer line defective. – Internal defect. 	<ul style="list-style-type: none"> – Check the connection of the sniffer line with the basic unit (disconnect and reconnect; if possible try a different sniffer line). – If the problem persists, please contact INFICON customer service.
W241	Voltage -12V out of range	<ul style="list-style-type: none"> – Sniffer line defective. – Internal defect. 	<ul style="list-style-type: none"> – Check the connection of the sniffer line with the basic unit (disconnect and reconnect; if possible try a different sniffer line). – If the problem persists, please contact INFICON customer service.
W250	Voltage +5V out of range	Internal defect	Please contact INFICON customer service.
W253	Wrong sniffer line voltage	Sniffer line defective.	<ul style="list-style-type: none"> – Check the connection of the sniffer line with the basic unit (disconnect and reconnect; if possible try a different sniffer line). – If the problem persists, please contact INFICON customer service.
3xx Measurement system error			
W322	Lamp voltage out of range	<ul style="list-style-type: none"> – Sniffer line connection or sniffer line is defective. – Internal defect in the basic unit. 	<ul style="list-style-type: none"> – Check the connection of the sniffer line with the basic unit (disconnect and reconnect; if possible try a different sniffer line). – If the problem persists, please contact INFICON customer service.
W324	Lamp current out of range	<ul style="list-style-type: none"> – Sniffer line connection or infra-red source in the sniffer line is defective. – Internal defect in the basic unit. 	<ul style="list-style-type: none"> – Check the connection of the sniffer line with the basic unit (disconnect and reconnect; if possible try a different sniffer line). – If the problem persists, please contact INFICON customer service.
W363	Sensitivity too low	<ul style="list-style-type: none"> – Optical cell is contaminated with water vapor. – The optical cell is dirty – The sensor in the sniffer line is defective. 	<ul style="list-style-type: none"> – Depending on the quantity of water inside the optical cell, let the HLD6000 run between 1 minute and two hours to clean the optical cell. – If the problem persists, please contact INFICON customer service.
W364	Sensitivity too high	Sniffer line defective.	Please contact INFICON customer service.

Table 10: Warning and error messages (Contin.)

No.	Message	Possible error sources	Troubleshooting
5xx Flow and pressure errors			
W543	Flow in the sniffer line is too low	<ul style="list-style-type: none"> – Filter in the sniffer tip is clogged – Sniffer tip is clogged or defective 	<ul style="list-style-type: none"> – Replace the filters – Check the connection of the sniffer line with the basic unit (disconnect and reconnect; if possible try a different sniffer line). – If the problem persists, please contact INFICON customer service.
W544	Valve does not toggle	Internal defect of the sniffer line.	<ul style="list-style-type: none"> – Check the connection of the sniffer line with the basic unit (disconnect and reconnect; if possible try a different sniffer line). – If the problem persists, please contact INFICON customer service.
W545	Flow at measuring line too low	<ul style="list-style-type: none"> – The filter in the sniffer tip is clogged. – Sniffer tip is clogged or defective. 	<ul style="list-style-type: none"> – Replace the filters – Check the connection of the sniffer line with the basic unit (disconnect and reconnect; if possible try a different sniffer line). – If the problem persists, please contact INFICON customer service.
W546	Leak at measuring line	<ul style="list-style-type: none"> – The filter in the sniffer tip is clogged. – Leak or defect in the sniffer tip or the sniffer line. 	<ul style="list-style-type: none"> – Replace the filters. – Check the plug and screw connections. – Check the connection of the sniffer line with the basic unit (disconnect and reconnect; if possible try a different sniffer line). – If the problem persists, please contact INFICON customer service.
W547	Flow at reference line too low	<ul style="list-style-type: none"> – Filter in the sniffer tip is clogged. – The sniffer tip is clogged or defective. 	<ul style="list-style-type: none"> – Replace the filters. – Check the connection of the sniffer line with the basic unit (disconnect and reconnect; if possible try a different sniffer line). – If the problem persists, please contact INFICON customer service.
W548	Leak at reference line	<ul style="list-style-type: none"> – The filter in the sniffer tip is clogged. – Leak or defect in the sniffer tip or the sniffer line. 	<ul style="list-style-type: none"> – Replace the filters – Check the plug and screw connections. – Check the connection of the sniffer line with the basic unit (disconnect and reconnect; if possible try a different sniffer line). – If the problem persists, please contact INFICON customer service.
W549	Measuring and reference line are swapped	<ul style="list-style-type: none"> – Poor calibration. – Internal defect on the sniffer line. 	<ul style="list-style-type: none"> – Recalibrate the device. – Please contact INFICON customer service.
6xx Calibration errors			
W630	Calibration request	Calibration out of date or no longer applicable.	<ul style="list-style-type: none"> – Recalibrate the device. – Select a suitable interval in the menu for the calibration request.
W631	Light barrier overdriven	The light barrier in the calibration opening gets too much light.	Avoid direct light and sunlight to the calibration opening.

Table 10: Warning and error messages (Contin.)

No.	Message	Possible error sources	Troubleshooting
W632	Light barrier blocked during run-up	Dust has accumulated in the calibration opening and is interrupting the light barrier.	<ul style="list-style-type: none"> – Switch the device off. – Blow out the calibration opening with clean compressed air. – Restart the device. <p>If this does not work, then calibrate externally with the COOL-Check or an external calibration leak.</p>
7xx Temperature errors			
W710	Temperature main board too high	<ul style="list-style-type: none"> – The ambient temperature is too high. – The fan is defective or blocked. 	<ul style="list-style-type: none"> – Decrease the temperature around the device. – Clean the ventilation openings or replace the filter plates. – Please contact INFICON customer service.
E711	Temperature main board far too high	<ul style="list-style-type: none"> – The ambient temperature is too high. – The fan is defective or blocked. 	<ul style="list-style-type: none"> – Switch off the device and allow it to cool down. – Decrease the temperature around the device. – Clean the ventilation openings or replace the filter plates. – Please contact INFICON customer service.
W730	Temperature COOL-Check out of range	<ul style="list-style-type: none"> – The basic unit is standing on a hot surface. – The temperature around the main unit is too high or too low. 	<ul style="list-style-type: none"> – Remove the device from the hot surface. – Decrease or increase the temperature around the device.
9xx Maintenance information			
W902	COOL-Check nearly empty	<ul style="list-style-type: none"> – The COOL-Check is empty. – The basic unit is set to a wrong date. 	<ul style="list-style-type: none"> – Change the COOL-Check. – Set the basic unit to the current date.
W903	COOL-Check is empty	<ul style="list-style-type: none"> – The COOL-Check is empty. – The basic unit is set to a wrong date. 	<ul style="list-style-type: none"> – Change the COOL-Check. – Set the basic unit to the current date.
W904	Replace the filter holder at sniffer tip	The filter of sniffer tip should be changed.	<ul style="list-style-type: none"> – Replace the filters. – Select a suitable interval in the "Filter change request" menu.

8 Maintenance

Carry out maintenance work on the device in accordance with the following description.

DANGER

Life threatening hazard from electric shock

Considerable voltages arise inside the device. Touching parts where electrical voltage is present can result in death.

- ▶ Disconnect the device from the power supply prior to any maintenance work. Ensure that the electricity supply cannot be switched back on unintentionally.

A Phillips-tip screwdriver is needed for some maintenance work.

8.1 Basic unit

8.1.1 Replacing the filter plates

Two filter plates on the base of the device filter dust out of the sucked-in air. If the filters are not replaced regularly then they become clogged. Functional filters are required to cool the ventilator.

For this reason, check the filter plates frequently for dirt.

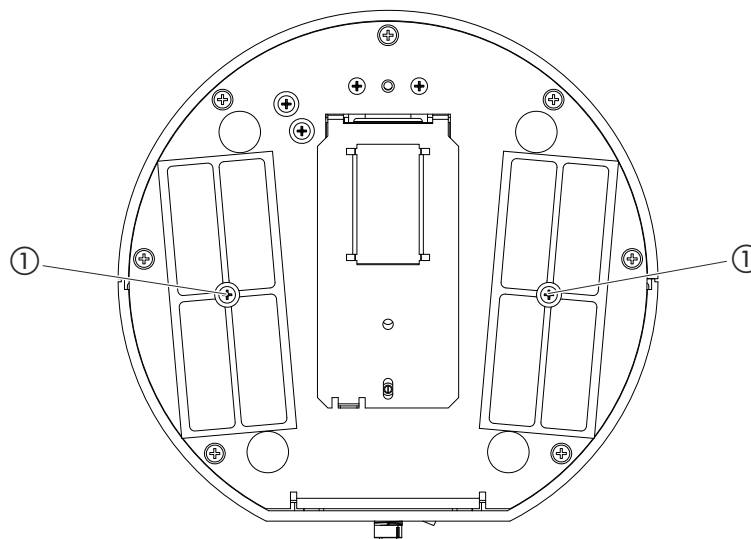



Fig. 15: View from below

① Screws for holding the cover for the filters

- 1  **DANGER**
Life threatening hazard from electric shock
 Switch off the device and disconnect from the mains.
 - 2 Carefully turn the basic unit onto its side.
 - 3 Loosen both screws in the middle of the filter holder, see "Fig. 15: View from below", page 63.
 - 4 Remove the filter plates.
 - 5 Clean the filter plates depending on the degree of pollution (e.g. with clean, compressed air or a brush) or replace the filter plates.
 - 6 Reinstall the filter plates.
 - 7 Tighten the screws in the middle of the filter holder.
- Replacement filter plates order no. 200 005 506, see "10.1 Accessories and spare parts", page 69.

8.1.2 *Cleaning the calibration opening*

A light barrier can be found in the calibration opening on the front of the basic unit, see "Fig. 1: Frontal view", page 14.

- ▶ To prevent interruption of the light barrier due to pollution, blow out the calibration frequently with clean, compressed air.

8.1.3 *Replacing the fuses*

The fuse holder of the device can be found beneath a cover alongside the mains plug at the back, see "Fig. 2: Rear view", page 15.

Replace the fuses as follows:

- 1  **DANGER**
Life threatening hazard from electric shock
 Switch off the device and disconnect from the mains.
- 2 Pull the plug of the power cable out of the device.
- 3 Carefully pull the cover out of the device with the fuses attached beneath until the fuse holder can be tipped over to one side.
- 4 Remove the fuses and check them for any damage.
- 5 If necessary, replace the fuses. The two fuses used must be exactly the same, see "Table 2: Technical data", page 17.
- 6 Press the fuse holder along with the fuses back into the starting position until the cover locks into place.

8.1.4 *Cleaning the device*

The housing of the device is composed of synthetic material.

- ▶ Switch off the device and disconnect from the mains.
- ▶ In cleaning the housing, use an agent accepted for synthetic surfaces (for example a light household cleaner). Do not use any solvents that attack synthetic materials.

8.2 Sniffer line

NOTICE

Material damage from compressed air

Compressed air can damage tine inside of the sniffer line.

- ▶ Never try to clean the probe or the filter holder with compressed air.

Two filters are built into the sniffer line of the device:

- Filter holder with fine filters in the sniffer tip,
- Filter block with fine filters at the base of the sniffer tip.

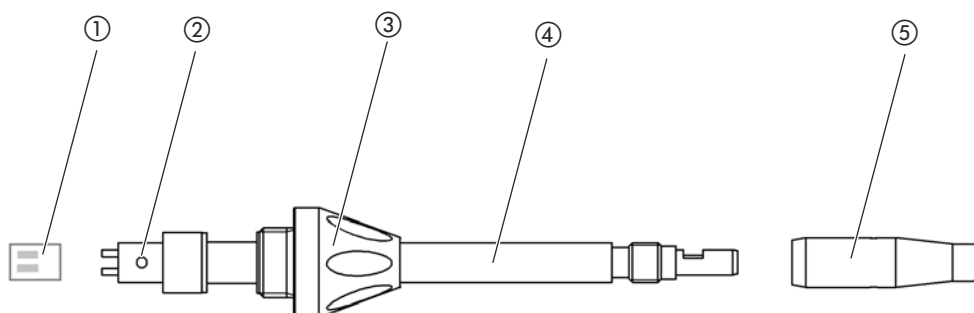

Fig. 16: The filters in the sniffer line

- | | |
|----------------|-----------------|
| ① Filter block | ④ Sniffer tip |
| ② Guide pin | ⑤ Filter holder |
| ③ Cap nut | |

8.2.1 Replacing the filter holder

- ▶ Replace the filter holder regularly after 40 operating hours.

To receive an automatic request to change the filter after 40 operating hours, activate this function in the device settings (see "6.3.7 Setting the filter change request", page 36).

When the filter holder has been changed and the request is confirmed then this function is reset. The request then reappears after 40 hours.

Regardless of the elapsed time, the device issues a warning or error message in case of pollution.

The fine filters in the sniffer tip are built into the filter holder see "Fig. 16: The filters in the sniffer line", page 65.

To change the filter holder:

- 1 Switch the device off.
- 2 Unscrew the filter holder from the sniffer tip.
- 3 Screw a new filter holder into position.

Replacement filter holder see "10.1 Accessories and spare parts", page 69

8.2.2 Changing the filter block

- ▶ Change the filter block with the integrated fine filters at least 1 x per month.

The filter block can be found at the base of the sniffer tip, see ["Fig. 16: The filters in the sniffer line", page 65](#). To replace the filter block, carry out the following:

- 1 Switch the device off.
- 2 Loosen the cap nut at the lower end of the sniffer tip and separate the sniffer tip from the probe handle.
- 3 Pull the filter block out of the base of the sniffer tip.
- 4 Insert a new filter block into position.
- 5 Attach the sniffer tip back onto the probe handle and tighten the cap nut at the lower end of the sniffer tip.

Replacement filter block see ["10.1 Accessories and spare parts", page 69](#)

8.3 Sending for repair or maintenance

You can send your device to INFICON to have it maintained or repaired. For further information regarding this topic see ["9.2 Sending in the device", page 67](#).

9 *Decommissioning the device*

9.1 *Disposing of the device*

The device can be disposed of by the operator or sent to INFICON.

The device consists of materials that can be recycled. This option should be exercised to prevent waste and also to protect the environment.

- ▶ During disposal, observe the environmental and safety regulations of your country.

9.2 *Sending in the device*

WARNING

Danger due to harmful substances

Contaminated devices could endanger the health of INFICON employees.

- ▶ Fill in the declaration of contamination completely.
- ▶ Attach the declaration of contamination on the outside of the packaging.

The declaration of contamination is a legal requirement and serves to protect our employees. Devices submitted without a completed Declaration of Conformity will be returned to the sender by INFICON.

Declaration of Contamination: See below.

Declaration of Contamination

The service, repair, and/or disposal of vacuum equipment and components will only be carried out if a correctly completed declaration has been submitted. Non-completion will result in delay.
This declaration may only be completed (in block letters) and signed by authorized and qualified staff.

1 Description of product

Type _____

Article Number _____

Serial Number _____

2 Reason for return

↓

3 Operating fluid(s) used (Must be drained before shipping.)

↓

4 Process related contamination of product:

toxic	no <input type="checkbox"/> 1)	yes <input type="checkbox"/>
caustic	no <input type="checkbox"/> 1)	yes <input type="checkbox"/>
biological hazard	no <input type="checkbox"/>	yes <input type="checkbox"/> 2)
explosive	no <input type="checkbox"/>	yes <input type="checkbox"/> 2)
radioactive	no <input type="checkbox"/>	yes <input type="checkbox"/> 2)
other harmful substances	no <input type="checkbox"/> 1)	yes <input type="checkbox"/>

2) Products thus contaminated will not be accepted without written evidence of decontamination!

The product is free of any substances which are damaging to health

yes

1) or not containing any amount of hazardous residues that exceed the permissible exposure limits

↓

5 Harmful substances, gases and/or by-products

Please list all substances, gases, and by-products which the product may have come into contact with:

Trade/product name	Chemical name (or symbol)	Precautions associated with substance	Action if human contact

↓

6 Legally binding declaration:

I/we hereby declare that the information on this form is complete and accurate and that I/we will assume any further costs that may arise. The contaminated product will be dispatched in accordance with the applicable regulations.

Organization/company _____

Address _____ Post code, place _____

Phone _____ Fax _____

Email _____

Name _____

Date and legally binding signature _____ Company stamp _____

This form can be downloaded from our website.

Copies: Original for addressee - 1 copy for accompanying documents - 1 copy for file of sender

INFICON GmbH

Bonner Str. 498,50968 Cologne, Germany
Tel: +49 221 56788-112 Fax: +49 221 56788-9112
www.inficon.com leakdetection.service@inficon.com

zisa01e1-b (1106)

Translation of the original operating instructions HLD6000, kinb43en1-03, 1604

68

9 Decommissioning the device

10 Appendix

10.1 Accessories and spare parts

Table 11: Accessories, spare parts, order no.

	Order no.
Basic unit	
Filter plate 133x55x3mm, 10 units	200 005 506
Sniffer line	
R744 (CO ₂)	511-045
R600a/R290	511-048
SMART (gas family of the HFC refrigerant)	511-047
Sniffer tip	
100 mm long, rigid, includes 6 filter holders and 5 filter blocks	511-021
400 mm long, bent, includes 6 filter holders and 5 filter blocks	511-022
400 mm long, flexible, includes 6 filter holders and 5 filter blocks	511-024
Extension hoses for the sniffer tip	
400 mm, flexible (20 units), including 1 centering ring and 1 adapter	511-020
400 mm, 45° angled (20 units), including 1 centering ring and 1 adapter	511-029
Filter for the sniffer tip	
Filter holder for the sniffer tip (20 units)	511-027
Filter block for the sniffer tip (20 units)	511-018
Extension of the sniffer line, 4.8 m	511-040
S-TL adapter for CO ₂ calibration, including 1 WK31/2 filter and 1 plastic hose, 2 m	511-042
Water conservation tip	511-025
COOL-Check calibration leak for SMART	511-010
External calibration leaks for individual coolants	
R744 (CO ₂), leakage rate 2 - 5 g/a	122 32
R744 (CO ₂), leakage rate 10 - 14 g/a	122 75
R600a, leakage rate 3 - 5 g/a	122 21
R290, leakage rate 7 - 8 g/a	122 31
Module	
I/O module	560-310
Data cable LD 2 m	560-332
Data cable LD 5 m	560-335
Data cable LD 10 m	560-340

10.2 Menu trees

Pressing the navigation button  brings you back to the measurement display regardless of whether you were previously in a menu or sub-menu.

Table 12: Menu tree "Settings"

	Setpoints	Leakage rate setpoint 1			
		Setpoint alarm			
		Leakage rate setpoint 2			
	Display settings	Value display			
		Value axis			
		Scaling value axis			
		Time axis			
		Units			
		Brightness			
		Display limits			
		Screenshot			
	Parameters	Load			
		Save			
		Reset			
		Parameter list			
		Parameter access level			
	Setup	Language			
		Calibration leak external			
		Auto standby			
		Interfaces	Device selection		
			I/O module	Analog outputs	
				Analog scale	
				Protocol	
				PLC outputs	
				PLC inputs	
			Units		
		Bus module	Address		
		Date and time	Date		
			Time		
		Sniffer line			
Request					
Advanced setup		Error information			
		SMART user gases	Factor user gas 1		
	Factor user gas 2				
	Factor user gas 3				
	Name user gas 1				
Name user gas 2					
Name user gas 3					
Gas					
Volume					
Recorder	Copy				
	Recorder settings				
	Delete				
Access control	Supervisor	PIN assign			
	Operator				

Table 13: Menu tree "Information"



	Basic unit
	COOL-Check
	I/O module
	Parameter list
	Sniffer line
	Operating unit
	Bus module

Table 14: Menu tree "Diagnosis"

	Active warnings	
	Service	Enter service PIN
	Histories	Error and warning history
		Calibration history
	Update	Basic unit
		Operating unit
		Sniffer line
		I/O module

10.3 CE Declaration of Conformity



EU Declaration of Conformity

We – INFICON GmbH - herewith declare that the products defined below meet the basic requirements regarding safety and health and relevant provisions of the relevant EC Directives by design, type and the versions which are brought in to circulation by us.

In case of any products changes made without our approval, this declaration will be void.

Designation of the product:

Halogen Sniffer Leak Detector

Models: **HLD6000**

Catalogue numbers:

510-025

510-027

510-028

Cologne, April 15th, 2016



Dr. Döbler, President LDT

The products meet the requirements of the following Directives:

- **Directive 2014/35/EU (Low Voltage)**
- **Directive 2014/30/EU (Electromagnetic Compatibility)**

Applied harmonized standards:

- **DIN EN 61010-1:2011**
- **DIN EN 61326-1:2013**
Class A according to EN 55011

Cologne, April 15th, 2016



Bausch, Research and Development

INFICON GmbH
Bonner Strasse 498
D-50968 Köln
Tel.: +49 (0)221 56788-0
Fax: +49 (0)221 56788-90
www.inficon.com
E-mail: leakdetection@inficon.com

Index

A

- Access control 39
- Access rights 39
- Accessories and spare parts 69
- Adjust volume 34

B

- Basic settings 34
- Bus module 39

C

- Calibrating the touchscreen 32
- Calibration 44
- Calibration - COOL-Check 45
- Calibration - external calibration leak 46
- Calibration - Touchscreen 32
- Calling up information 51
- Check calibration 47
- Connecting a PC 27
- Connecting the sniffer line 23
- Connecting the USB stick 27
- COOL-Check 27

D

- Dangers 10
- Decommissioning the device 67
- Dimensions 17

E

- Error messages 57
- Extension hose 26

F

- Factor user gas 44
- Factory settings 18, 20
- Function symbols 30

G

- Gas flow 18

I

- I/O module 36

L

- Load parameters 41

M

- Measuring 48
- Menu trees 70

N

- Name user gas 43

O

- Operator requirements 10
- Owner requirements 9

P

- Parameter access controls 20, 40
- Parameter list 52
- PIN assign 40

R

- Replacing the sniffer tip 24

S

- Save parameters 41
- Scope of delivery 11
- Screenshot 41, 49
- Setting setpoints 42
- Settings for measurements 42
- Setup the alarm type 43
- Shipment 11
- SMART sniffer line 43
- Sniffer handle 33
- Sniffer tip 69
- Storage 11

T

- Technical data 17
- Transport 11

U

- Updating the software 53
- USB stick recording 49
- User-defined gases 43
- Using a water conservation sniffer tip 25

V

- Volume 34

W

- Warning symbols 10



INFICON GmbH, Bonner Strasse 498, D-50968 Cologne, Germany
leakdetection@inficon.com

UNITED STATES TAIWAN JAPAN KOREA SINGAPORE GERMANY FRANCE UNITED KINGDOM HONG KONG
Visit our website for contact information and other sales offices worldwide. www.inficon.com

Document: kinb43en1-03 1604